

AUDIO VIDEO SURROUND RECEIVER  
**KRF-V5010/V5010E/V5010W/  
 V6010/V6010E/V6010W/  
 V7010/V7010E/V7010W/  
 VR-205/207/255/257**  
**SERVICE MANUAL**

**KENWOOD**

© 1998-4/B51-5425-00 (K/K) 3484

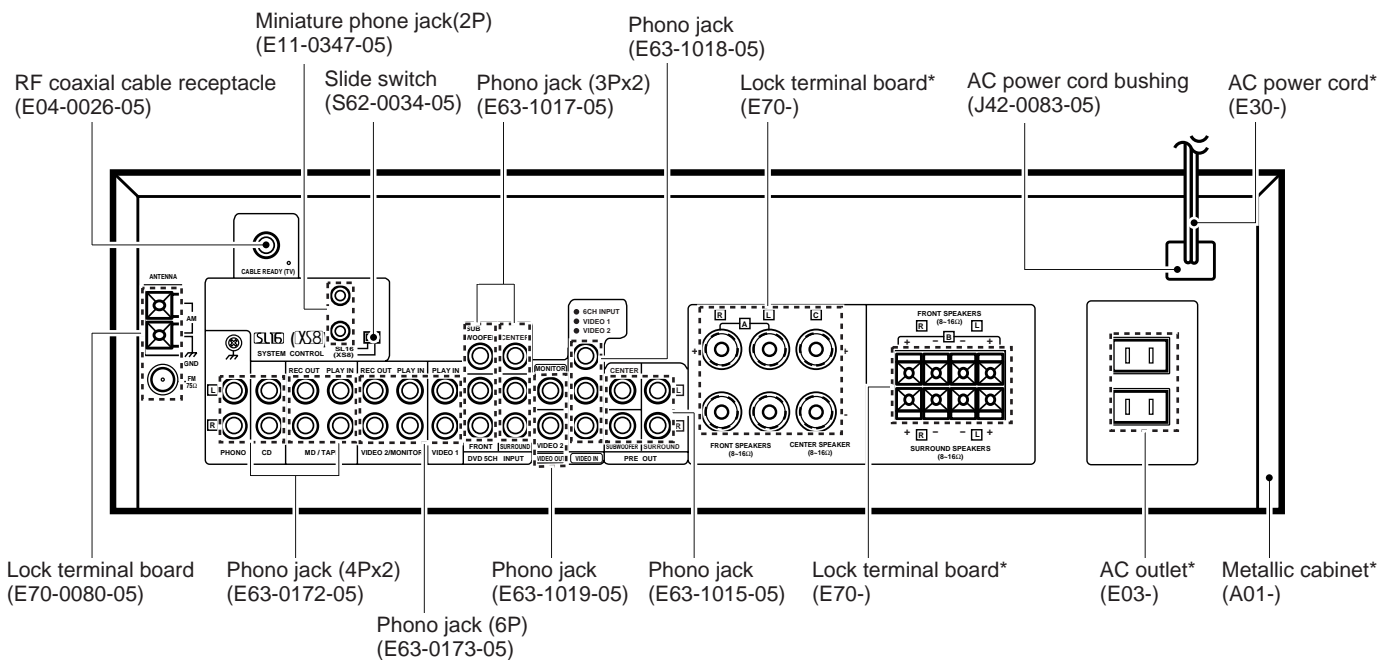
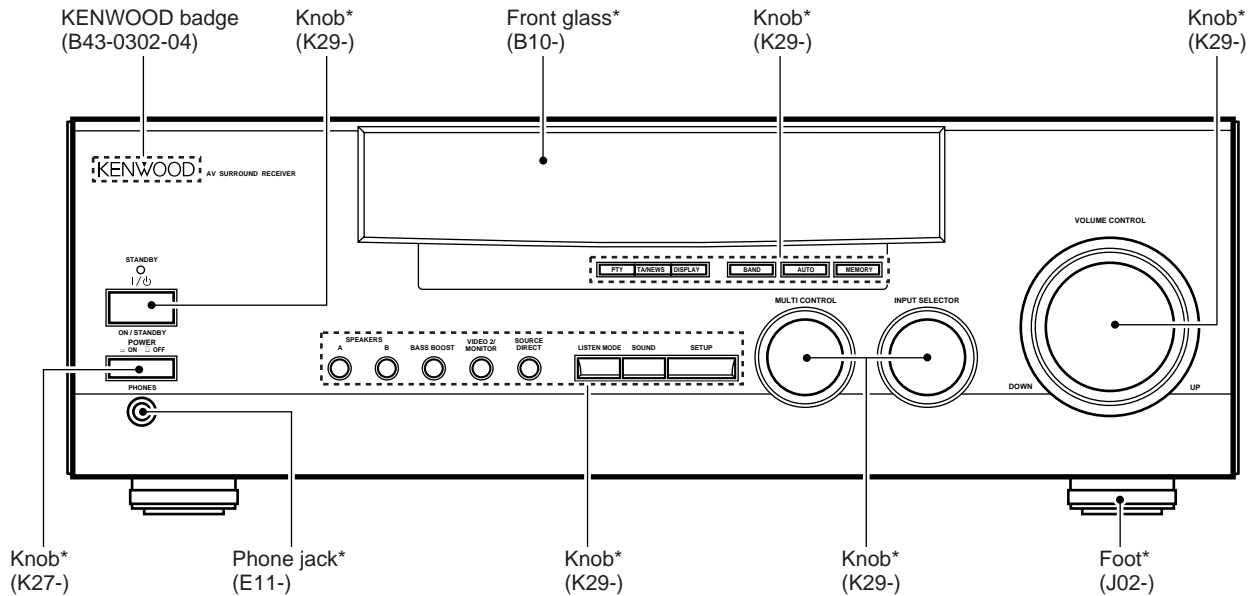

\* Refer to parts list on page 33.

# KRF-V5010/V6010/V7010/VR-205/206/207/255/257

## CONTENTS / ACCESSORIES

### Contents

CONTENTS / ACCESSORIES .....	2	ADJUSTMENT .....	13
CONTROLS .....	3	PC BOARD .....	14
DISASSEMBLY FOR REPAIR .....	5	SCHEMATIC DIAGRAM .....	17
WIRING DIAGRAM .....	6	EXPLODED VIEW .....	32
BLOCK DIAGRAM .....	7	PARTS LIST .....	33
CIRCUIT DESCRIPTION .....	8	SPECIFICATIONS .....	47

### Accessories

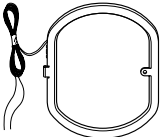
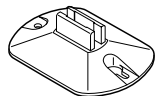
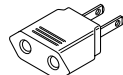
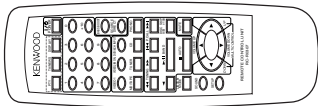
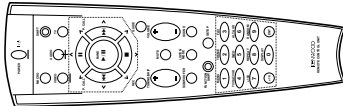
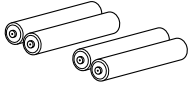
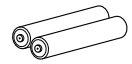
<p>FM indoor antenna (1) (T90-0836-05)</p> 	<p>AM loop antenna (1) (T90-0833-05)</p> 	<p>Loop antenna stand (1) (J19-3645-05)</p> 	<p>AC plug adaptor (1) (E03-0115-05)</p>  <p>*Use to adapt the plug on the power cord to the shape of the wall outlet. (Accessory only for regions where use is necessary.)</p>
<p>Remote control unit (1) RC-R0307/R0407</p> 	<p>Remote control unit (1) RC-R0507/R0607</p> 	<p>Batteries (R03/AAA) (4)</p> 	<p>Batteries (R06/AA) (2)</p> 

### Model name vs remote controller

Remote controller		Model name	Destination	Battery cover	
Parts number	Model name				
A70-1194-05	RC-R0607	VR-207	KP1	A09-0366-08	
		VR-257	K1P2		
		VR-255	K1P2		
		KRF-V7010	Y1M1		
A70-1195-05	RC-R0507	KRF-V7010	X1E1T1		
		KRF-V7010W	Q1		
		KRF-V7010E	E2		
A70-1196-05	RC-R0307	KRF-V6010	E		A09-0396-08
		KRF-V6010W	Q1		
		KRF-V6010E	E1		
		KRF-V5010	E1T1		
		KRF-V5010W	Q1		
		KRF-V5010E	E2		
A70-1199-05	RC-R0407	VR-206	K2P3		
		KRF-V6010	M1X1		
		VR-205	KP1		
		KRF-V5010	Y1M1X1		

### Resetting the Microcomputer

If the microcomputer may malfunction (unit cannot be operated, or shows an erroneous display) if the power cord is unplugged while the power is ON, or due to some other external factor. If this happens, execute the following procedure to reset the microcomputer and return the unit to its normal operating condition.

For U.S.A. and Canada

Unplug the power cord from the wall outlet, then plug it back in while holding down the POWER key.

For other countries

With the power cord plugged in, turn the POWER key OFF. Then, while holding down the ON/STANDBY key, press POWER.

- Please note that resetting the microcomputer will clear the contents of the memory and returns the unit to the state it was in when it left the factory.

# KRF-V5010/V6010/V7010/VR-205/206/207/255/257

## CONTROLS

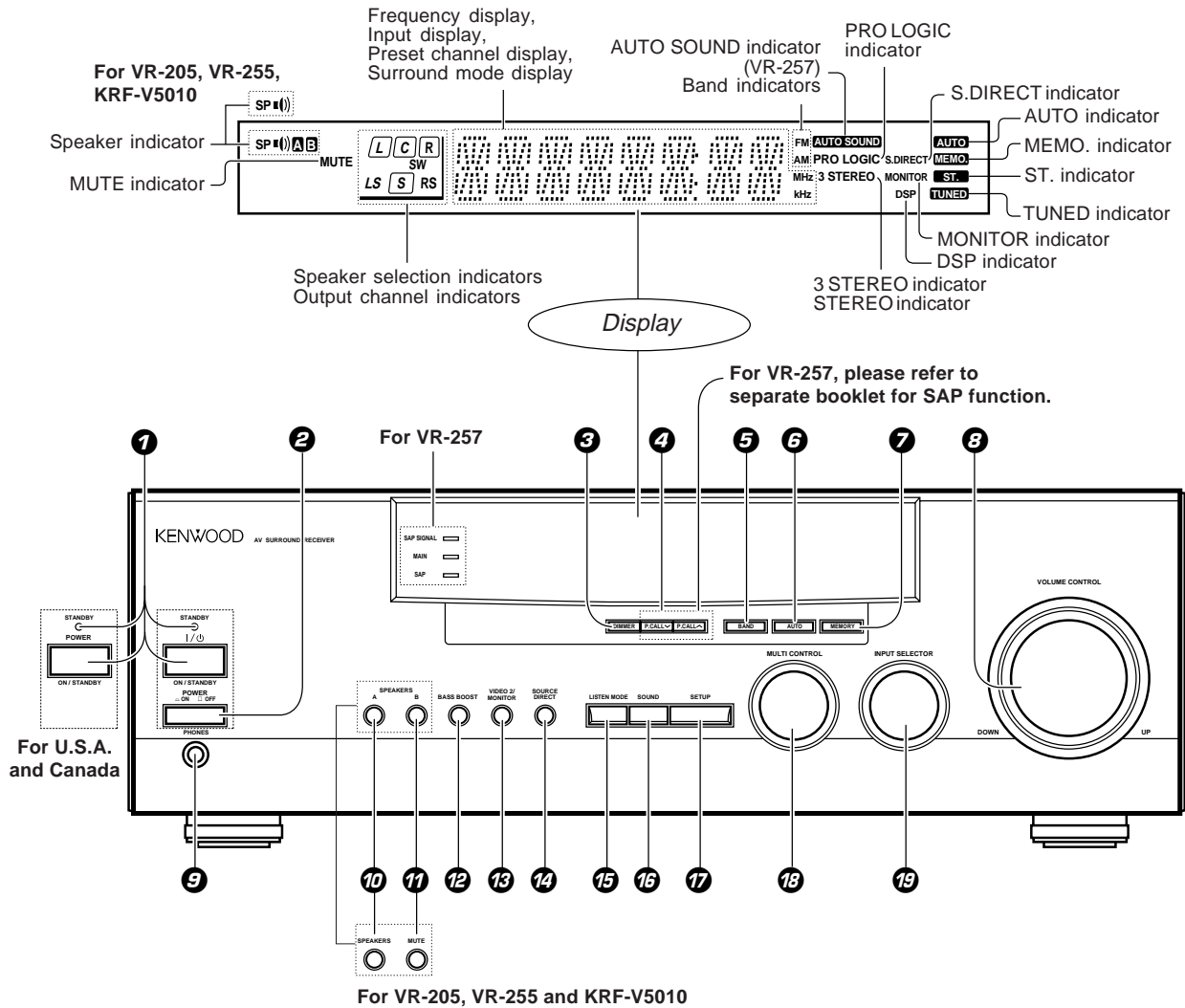

- 1 POWER key**  
(For U.S.A. and Canada)  
Use to turn the power ON/OFF.  
**STANDBY indicator**
- 1 ON/STANDBY (1/0) key**  
(Except for U.S.A. and Canada)  
Use to switch the power ON/STANDBY when the POWER is turned ON.  
**STANDBY indicator**
- 2 POWER key**  
(Except for U.S.A. and Canada)
- 3 DIMMER key**  
Use to adjust the brightness of the display.
- 4 P.CALL keys (Except for VR-257)**  
Use to call up previously registered radio stations.
- 5 BAND key**  
Use to select the broadcast band.
- 6 AUTO key**  
Use to select the auto tuning mode.
- 7 MEMORY key**  
Use to store radio stations in the preset memory.
- 8 VOLUME CONTROL knob**
- 9 PHONES jack**  
Use for headphone listening.
- 10 SPEAKERS A key**  
Use to turn speaker system A on and off.  
**SPEAKERS key (VR-205, VR-255, KRF-V5010)**  
Use to turn the speakers on and off.
- 11 SPEAKERS B key**  
Use to turn speaker system B on and off.  
**MUTE key (VR-205, VR-255, KRF-V5010)**  
Use to temporarily mute the sound.
- 12 BASS BOOST key**  
Use to select the maximum adjustment setting for the low frequency range.
- 13 VIDEO 2/MONITOR key**
- 14 SOURCE DIRECT key**
- 15 LISTEN MODE key**  
Use to select the listening mode.
- 16 SOUND key**  
Use to adjust the sound quality and ambience effects.
- 17 SETUP key**  
Use to select the surround sound settings.
- 18 MULTI CONTROL knob**  
Used to make a variety of settings.
- 19 INPUT SELECTOR knob**  
Use to select the input sources.

### About the STANDBY indicator

This unit has a STANDBY indicator. When the STANDBY indicator is lit, the unit consumes a small amount of power to preserve the memory. This is called STANDBY mode. This mode also lets you turn the power ON using the remote control.

# CONTROLS

## Remote control unit (RC-R0407)

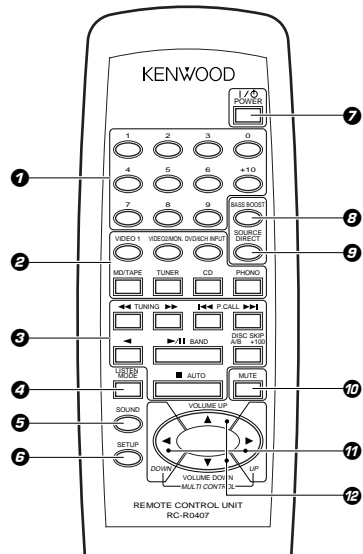

- 1 Numeric keys**  
If CD or MD is selected as the input source, these keys function as numeric keys. If tuner is selected as the input source, these keys are used to call up station presets.
- 2 Input selector keys**  
Use to select the receiver's input source.
- 3 Component operation keys**  
Use these keys to operate other components with system control connections to the receiver.  
**TUNING (◀▶) keys**  
If tuner is selected as the input source, these keys function as tuning keys.  
If CD or MD is selected as the input source, these keys function as search keys.  
**P.CALL (◀▶) keys**  
If tuner is selected as the input source, these keys function as P.CALL keys.  
If CD or MD is selected as the input source, these keys function as skip keys.
- 4 BAND (▶||) key**  
If tuner is selected as the input source, this key functions as the band selector key.  
If CD is selected as the input source, this key functions as the play/pause key.  
If MD is selected as the input source, this key functions as the play key.  
**DISC SKIP, A/B, +100 key**  
If CD is selected as the input source, this key functions as the multi-CD player disc skip key.  
If TAPE is selected as the input source, this key is used to switch between the two decks (A and B) of a double cassette deck.  
**AUTO key**  
If tuner is selected as the input source, this key functions as the AUTO key.  
If CD or MD is selected as the input source, this key functions as the stop key.
- 5 ▶ key**  
If tape is selected as the input source, this key functions as the play key for side B of the cassette (the side facing away from the front of the deck).
- 6 BAND (▶||) key**  
If tuner is selected as the input source, this key functions as the band selector key.  
If CD is selected as the input source, this key functions as the play/pause key.  
If MD is selected as the input source, this key functions as the play key.
- 7 LISTEN MODE key**  
Use to select the listening mode.
- 8 SOUND key**  
Use to adjust the sound quality and ambience effects.
- 9 SETUP key**  
Use to select the surround sound settings.
- 10 POWER key**  
Use to switch the power ON/STANDBY when the POWER is turned ON.
- 11 BASS BOOST key**  
Use to select the maximum adjustment setting for the low frequency range.
- 12 SOURCE DIRECT key**  
Use to temporarily mute the sound.
- 13 MULTI CONTROL key**  
Used to make a variety of settings.
- 14 VOLUME CONTROL key**  
Use to adjust the volume of the subwoofer.

## Remote control unit (RC-R0607, RC-R0507)

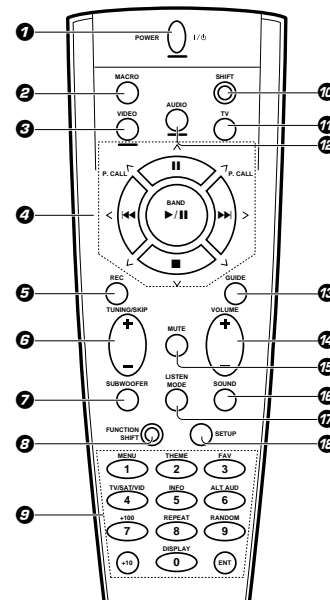

- 1 POWER key**  
Use to turn the receiver on and off.
- 2 MACRO key**  
Use in combination with the AUDIO, VIDEO, or TV keys to execute a series of commands automatically (MACRO PLAY).
- 3 VIDEO selector key**  
Selects the video inputs and sets the remote control to operate the component registered at the respective input.
- 4 Multi control keys**  
Use to operate the selected component.
- 5 REC key**  
Use to operate the selected component.
- 6 TUNING/SKIP key**  
Use during the setup procedure to specify various settings. Use to operate the tuner or selected component.
- 7 SUBWOOFER key**  
Use in combination with the VOLUME +/- keys to adjust the volume of the subwoofer.
- 8 FUNCTION SHIFT key**  
Use in combination with the numeric keys to execute alternate commands.
- 9 Numeric keys**  
Provide functions identical to those of the original remote control supplied with the component you are controlling. To access the functions printed above the keys, press within 3 seconds of pressing the FUNCTION SHIFT key. Function availability varies for each component.
- 10 SHIFT key**  
Use in combination with the AUDIO and VIDEO keys to change the remote control mode without changing the input selector or in combination with the POWER key to turn on and off components programmed into the remote control.
- 11 TV selector key**  
Sets the remote control to operate a TV or cable box. This key does not change the input selector on the receiver.
- 12 AUDIO selector key**  
Selects the audio inputs and sets the remote control to operate the respective KENWOOD audio component. If you connect audio components from KENWOOD and other makers to the MD/TAPE or CD jacks, you can set the remote control to operate these components by registering the appropriate setup code at the respective input.
- 13 GUIDE key**  
Use to activate the OSD menu functions of registered components.
- 14 VOLUME key**  
Use to adjust the receiver volume.
- 15 MUTE key**  
Use to temporarily mute the sound.
- 16 SOUND key**  
Use to adjust the sound quality and ambience effects.
- 17 LISTEN MODE key**  
Use to select the listening mode.
- 18 SETUP key**  
Use to select the surround sound settings.

There are some cases in which keys (or knobs) that have the same function on the receiver and on the remote control have different names. In the instructions of this manual, if the names of corresponding keys (or knobs) on the receiver and remote control are different, the name of the remote control key is indicated in parentheses.

# KRF-V5010/V6010/V7010/VR-205/206/207/255/257

## DISASSEMBLY FOR REPAIR

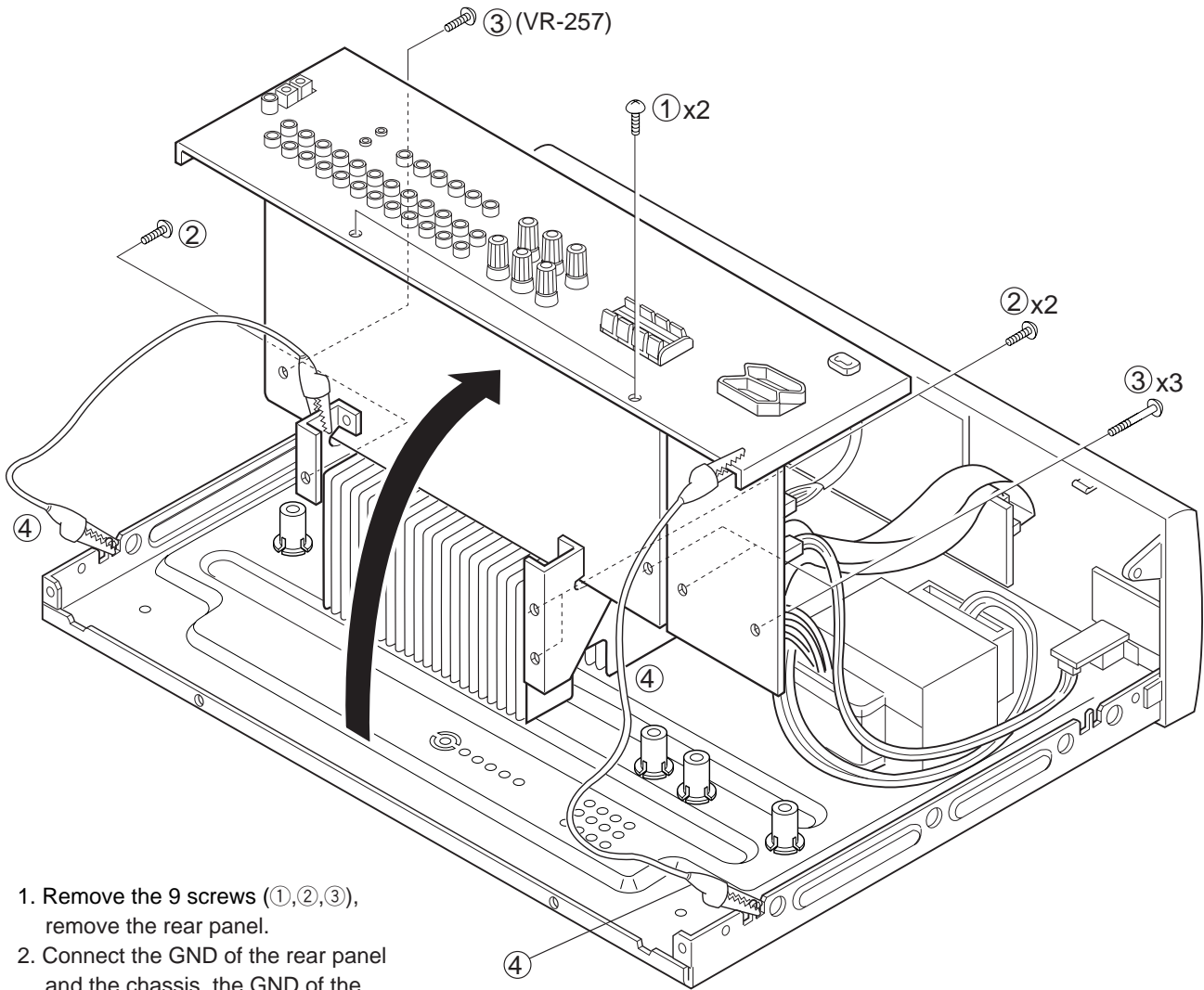

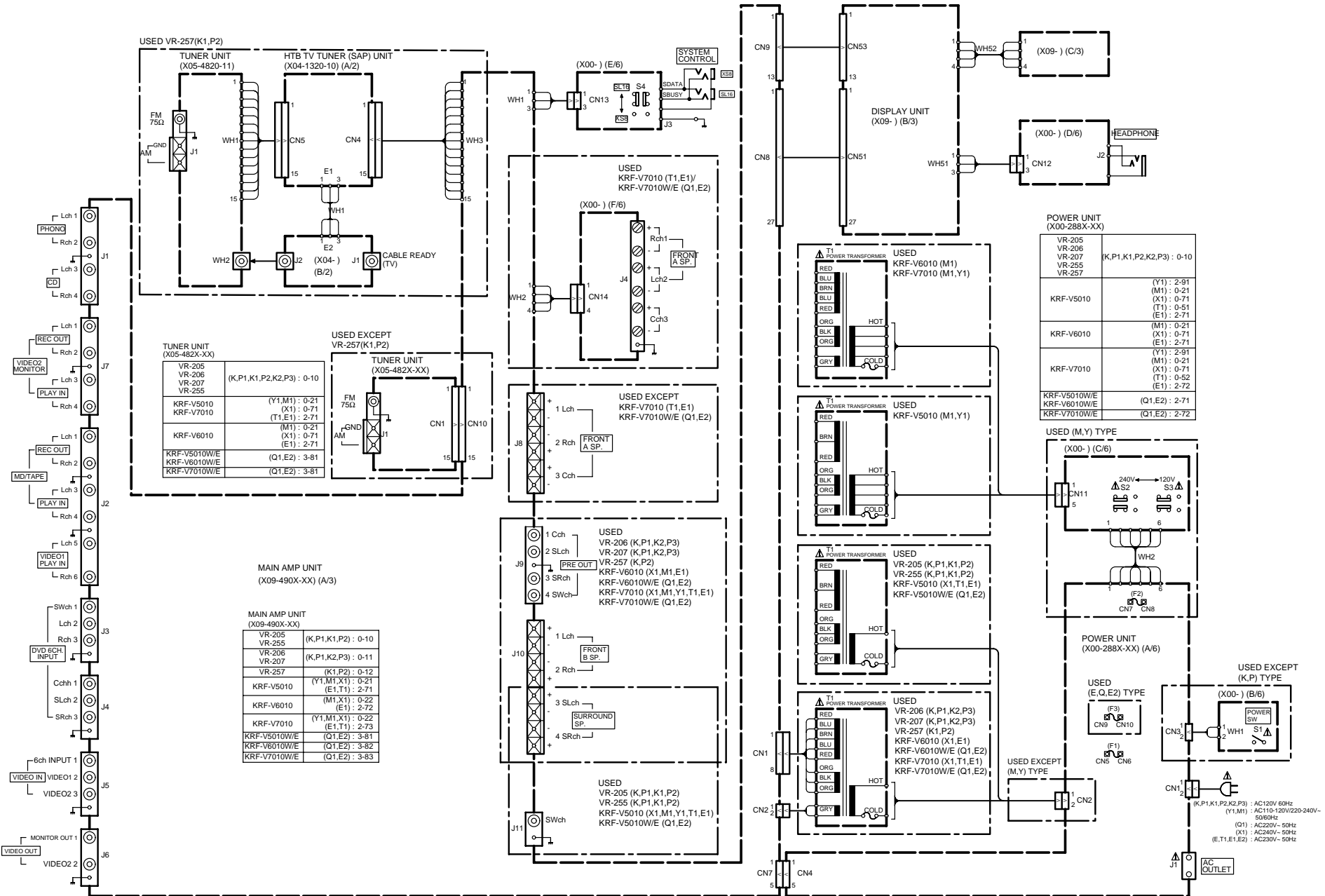

VR-205/206/207/255/257 (K)  
 KRF-V5010/V5010E/5010W/V6010/V6010E/V6010W/V7010/V7010E/V7010W (E)

# KRF-V5010/V6010/V7010/VR-205/206/207/255/257

## BLOCK DIAGRAM

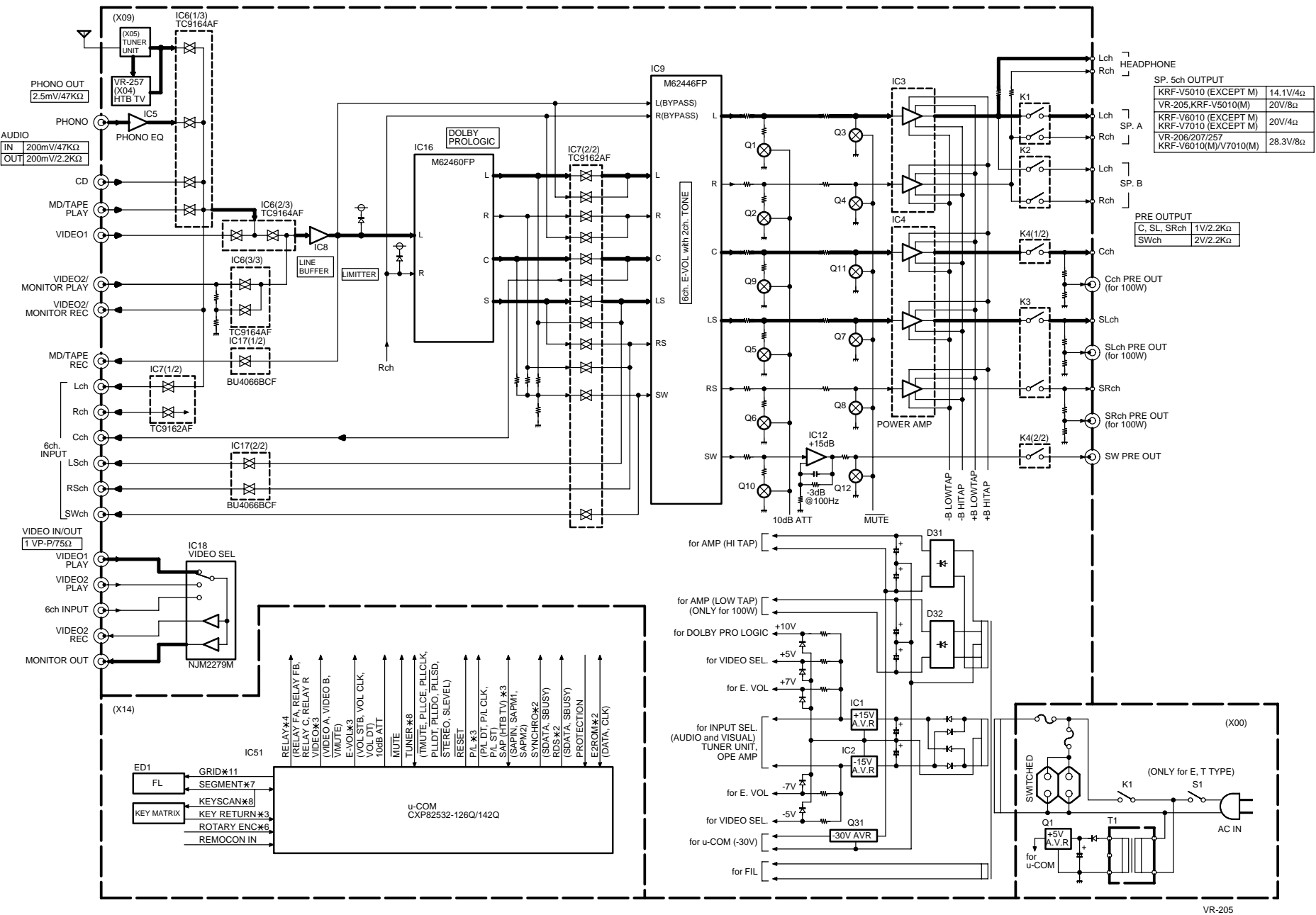

VR-205

# KRF-V5010/V6010/V7010/VR-205/206/207/255/257

## CIRCUIT DESCRIPTION

### 1. BACK UP DATA AND INITIAL STATE

#### 1-1 BACK UP

##### (1) AMP

- POWER.....STAND BY
- INPUT SELECTOR .....TUNER
- SELECTOR FRESET .....NONE
- VIDEO OUTPUT.....VIDEO1
- SPEAKER A RELAY .....ON
- SPEAKER B RELAY .....OFF
- VOLUME LEVEL .....-78dB
- BASS LEVEL.....0dB
- TREBLE LEVEL .....0dB
- INPUT LEVEL.....0dB
- BASS BOOST .....OFF
- SOURCE DIRECT .....OFF
- SUB WOOFER .....YES
- MONITOR.....OFF
- SL16/XS8 .....SL16
- DIMMER LEVEL.....LIGHT

##### (2) SURROUND

- LISTEN MODE .....STEREO
- INPUT MODE .....DIGITAL AUTO
- CENTER SPEAKER.....NORMAL
- SURROUND SPEAKER....YES
- DISTANCE .....Fch 3.0m/10ft  
Cch 3.0m/10ft  
Sch 3.0m/10ft
- LEFT LEVEL.....0dB
- RIGHT LEVEL .....0dB

- CENTER LEVEL.....0dB
- REAR (LS, RS) LEVEL.....0dB
- SUB WOOFER LEVEL.....0dB
- MID NIGHT .....OFF

##### (3) TUNER

- BAND.....FM(EXCEPT VR-257)  
TV (VR-257)
- FRESET CHANNEL ....."- -"
- FREQUENCY .....MINIMUM FREQUENCY  
J1 .....FM : 76.00MHz  
AM : 531kHz  
K1 .....FM : 87.50MHz  
AM : 530kHz  
E1/E3.....FM : 87.50MHz  
AM : 531kHz  
Q1 .....FM : 65.00MHz  
AM : 531kHz  
VR-257.....TV : 3ch
- SAP MODE.....STEREO (VR-257)
- AUTO/MANUAL.....AUTO
- DISPLAY MODE.....FREQUENCY
- EON THRUST  
RECEIVING MODE .....OFF
- M TYPE SETTING  
MODE (K2/E1).....E1

#### 1-2 INITIAL SETTING

The initial setting is performed when the AC power cord is plugged into the AC power wall outlet while pressing the power (STANDBY) key.

### 2. DIFFERENCE POINT OF MODEL (VR-209/207)

Model		VR-205/206 KRF-V5010/6010	VR-207/255/257 KRF-V7010	VR-208/209 KRF-V8010D
Function				
REMOCON		NORMAL REMOTE RC-R0407 K, P, M, C, X, Y RC-R0307 E, T, Q	PRESET REMOTE RC-R0607 K, P, M, C, Y RC-R0507 E, T, Q, X	PRESET REMOTE RC-R0607 K, P, M, C, Y
SELECTOR	AUDIO	TUNER CD TAPE/MD PHONO	TUNER CD TAPE/MD PHONO	TUNER CD TAPE/MD PHONO
	VISUAL & AUDIO	VIDEO1 VIDEO2/MONITOR DVD 6ch INPUT	VIDEO1 VIDEO2/MONITOR DVD 6ch INPUT	VIDEO1 VIDEO2 VIDEO3
MONITOR	FUNCTION	VIDEO2/MONITOR	VIDEO2/MONITOR	MONITOR
	ON LEVEL	2 step (0/-6)	2 step (0/-6)	3 step (0/-3/-6)
SPEAKER		SP.A/SP.B (206) SP.1 stage (205/255)	SP.A/SP.B	SP.A/SP.B
DIGITAL AUTO		X	X	O
DOLBY DIGITAL		X	X	O
INPUT MODE (VIDEO2/ VIDEO3)		X	X	DIGITAL AUTO/ DIGITAL MANUAL/ ANALOG
LIVE, HALL		O	O	X
SOUND LEVEL		Sch	Sch	RSch/LSch
TUNER	TV & SAP	X	VR257	X
	RDS	E, T, Q	E, T, Q	X



## CIRCUIT DESCRIPTION

### FUNCTION DIODE MATRIX (X14-)

Model Function	VR-205/255 KRF-V5010	VR-206/207 KRF-V6010/V7010	VR-257	VR-209 KRF-V8010
DOLBY DIGITAL	X	X	X	D503
SPEAKER A only	D522	X	X	X
TV & SAP	X	X	D506	X

### 3. DESTINATION LIST OF TUNER

#### • TUNER

Destination	TUNER type	BAND	Receiving frequency range	Channel space	IF	PLL reference frequency	Diode SW			
							DSW3	DSW2	DSW1	DSW0
							D507	D505	D504	D510
K, P, R	K1 1700	FM	87.5MHz~108.0MHz	100kHz	+10.7MHz	25kHz	0	0	0	0
		AM	530kHz~1700kHz	10kHz	+450kHz	10kHz				
Y, M, I, C, V, E, X, H	E1	FM	87.5MHz~108.0MHz	50kHz	+10.7MHz	25kHz	0	0	1	1
		AM	531kHz~1602kHz	9kHz	+450kHz	9kHz				
T	E2 LW	FM	87.5MHz~108.0MHz	50kHz	+10.7MHz	25kHz	0	1	0	0
		MW	531kHz~1602kHz	9kHz	+450kHz	9kHz				
		LW	153kHz~279kHz	9kHz	+450kHz	9kHz				
E	E3 RDS	FM	87.5MHz~108.0MHz	50kHz	+10.7MHz	25kHz	0	1	0	1
		AM	531kHz~1602kHz	9kHz	+450kHz	9kHz				
Q	Q1 RDS	FML	65.0MHz~74.0MHz	10kHz	+10.7MHz	5kHz	1	0	1	1
		FMH	87.5MHz~108.0MHz	50kHz	+10.7MHz	5kHz				
		AM	531kHz~1602kHz	9kHz	+450kHz	9kHz				

※ 0 : NONE DIODE, 1: ADD DIODE

#### 3-1 Channel Space Selector in Broadcasting setting

1. Push the BAND key for 2 seconds in the standby mode.
2. Display shows "F100/A10kHz" or "F50/A9kHz" blinkingly for 5 seconds.
3. Turn the VOLUME knob (Encoder) to choose your channel space.
4. Push the BAND key to memorize the channel space to E2P ROM.

Note : Channel space will be set by the data from E2P ROM if reconnect the power cord..

Channel space will be set by the destination data from E2P ROM if backup data damaged.

### 4. TEST MODE

#### 4-1 SETTING

Turn the power ON while pressing the [BAND] key.

#### 4-2 CANCEL

Unplug the AC power cord from an AC power wall outlet.

#### 4-3 STARTING ACTIVE CONTENTS

- ① The power on state is entered whenever the power is turned on while pressing the [BAND] key. All functions are then initialized and activated in the all-lighting mode.
- ③ All lighting mode is canceled when any main unit's keys are pressed. The normal display obtained when the selector is set to TUNER then appears.

#### ③ E2P ROM check (E, T, Q, M, V type)

Check the reading data and the writing data of the E2P ROM after setting the test mode.

Display shows blank if the reading and writing data is the same. Display shows "□" if the different.

Data (FM 50kHz, AM 9kHz, De-emphasis 50us) will be written to E2P ROM if the unit for M and V type.

#### 4-4 ACTIVE CONTENTS

- ① The mute control is not activated when the mode is switched.
- ② The test mode will be terminated by plugging it off the power source or by initializing it, when all the settings will be initialized.
- ③ During the test mode, it can be operated in a special manner that is different from an ordinary operation by using the keys on the remote control or the main body, specifically as shown in the following table (5. contents).
- ④ Channel space will be no change if set channel space in the reset mode.

#### 4-5 CONTENTS

TUNER (E, T, Q, RDS ONLY)

OPERATION KEY	FUNCTION	FL DISPLAY	Remarks
PTY	• S LEVEL	(EXP.)	(1) (2)↕(3) CYCLIC
	• RF ATT	(1) (S LEVEL), (RF ATT) OFF	
		(2) (S LEVEL), (RF ATT) ON	
DISPLAY	P. CALL UP	(3) (NORMAL), (RF) ATT OFF	
BASS BOOST	P. CALL DOWN	P. CALL FREQUENCY	

## CIRCUIT DESCRIPTION

EXCEPT TUNER (BELOW ※ : TONE, CH. LEVEL is selected SOUND key.)

OPERATION KEY	INPUT LEVEL	FUNCTION	FL DISPLAY
※ BAND	-6dB	BASS, TREBLE each CH.	-10dB -89dB
※ AUTO	-3dB	BASS, TREBLE each CH.	+10dB 0dB
※ MEMORY	0dB	BASS, TREBLE each CH.	0dB -78dB
P. CALL ∨	—	MUTE	ON OFF
P. CALL ∧	—	CH. DELAY TIME	DMAX DMIN

### 5. Microprocessor periphery diagram

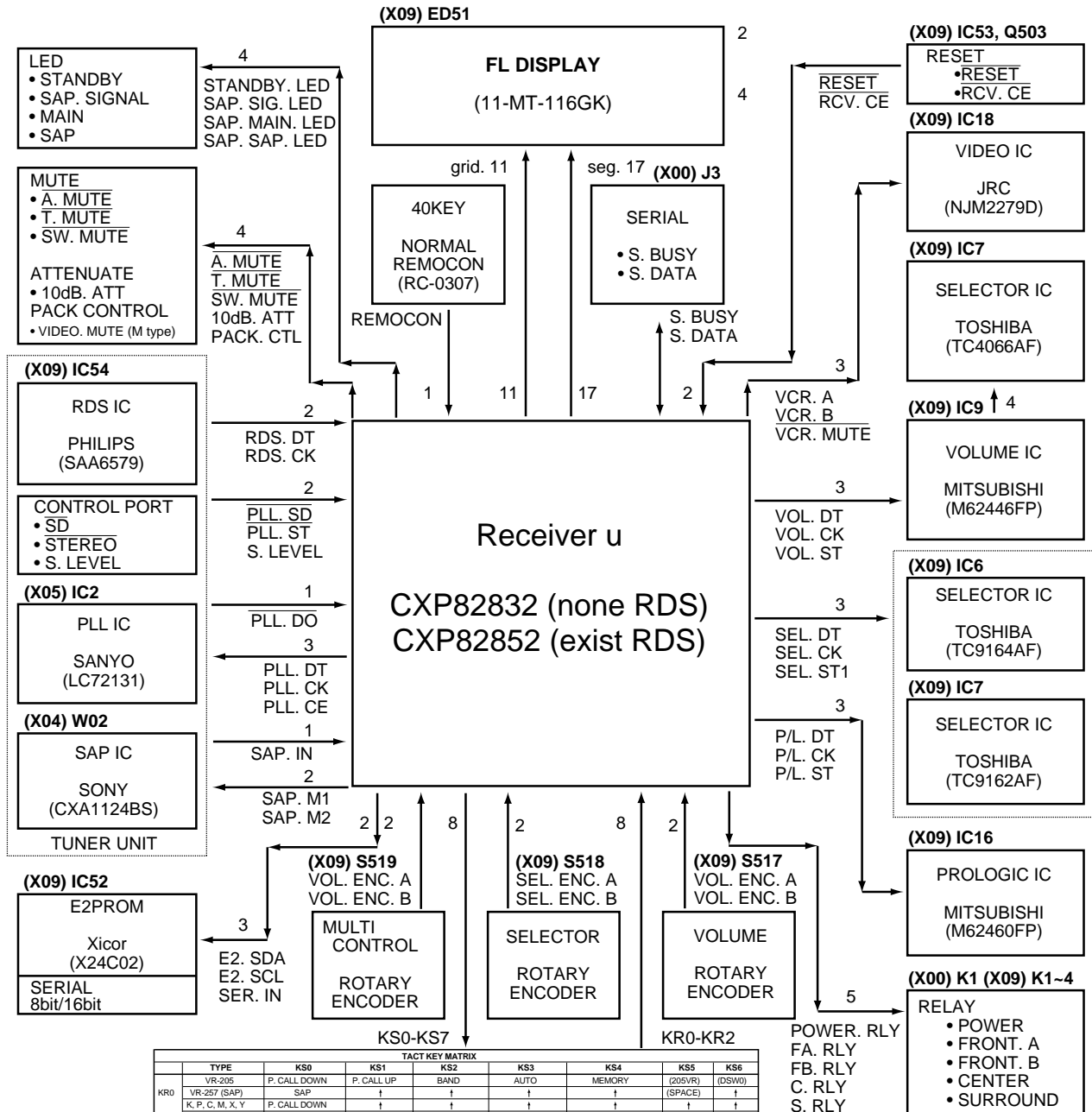

TYPE	TACT KEY MATRIX							
	KS0	KS1	KS2	KS3	KS4	KS5	KS6	
KR0	VR-205 (SAP)	P. CALL DOWN	P. CALL UP	BAND	AUTO	MEMORY	(SPACE)	(DSW0)
	K, P, C, M, X, Y	SAP						
	E, T, Q (RDS)	T. NEWS	DISPLAY					
KR1	VR-205	ON/STANDBY	DIMMER	SOUND	LISTEN MODE	SETUP	(SPACE)	(DSW1)
	VR-257 (SAP)							
	K, P, C, M, X, Y		PTY					
KR2	VR-205	SPEAKER	MUTE	BASS BOOST	MONITOR	SOURCE DIRECT	(SPACE)	(DSW2)
	VR-257 (SAP)	SPEAKER A	SPEAKER B					
	K, P, C, M, X, Y							
E, T, Q (RDS)								

## CIRCUIT DESCRIPTION

## 6. Microprocessor pin description

Pin No.	Pin name	I/O	Description	Active
1, 2	G10~G11	O	FL (11-MT-116GK) GRID 10, 11	
3	–	–	Unused	
4	RDS. CK	I	RDS IC (SAA6579) clock input control	
5	RDS. DT	I	RDS IC (SAA6579) data input control	
6	–	I	Unused	
7	VOL. ENC. A	I	Volume encoder A (CW) signal	
8	REMOCON	I	Remote control	
9	VOL. ENC. B	I	Volume encoder B (CCW) signal	
10, 11	–	O	Unused	
12~14	KR0 - KR2	I	Key return 0~2	
15	PROTECT	I	Protection detect	H : PROTECT
16	S. DATA	I/O	Serial communication data	
17	S. BUSY	I/O	Serial communication busy	
18	E2. DT	I/O	E2PROM data	
19	E2. CLK	O	E2PROM clock	
20	SEL. ENC.A	I	Selector encoder A (CW)	
21	SEL. ENC.B	I	Selector encoder B (CCW)	
22	MULTI. ENC.A	I	Multi control encoder A (CW)	
23	MULTI. ENC.B	I	Multi control encoder B (CCW)	
24	SER.IN	I	Serial communication 8bit/16bit changeover	L : 8bit      H : 16bit
25	SAP.M1	O	SAP IC (CXA1124BS) M1 control	
26	SAP.IN	I	SAP IC (CXA1124BS) SAP signal control	L : sap
27	SAP.M2	O	SAP IC (CXA1124BS) M2 control	
28	Vdd	–	Analog power supply (+5V)	
29	S.LEVEL	I	Signal level A/D input	
30	P/L. DT	O	PROLOGIC IC (M62460FP) strobe	L : active
31	P/L. CK	O	PROLOGIC IC (M62460FP) clock	L : active
32	P/L. ST	O	PROLOGIC IC (M62460FP) data	
33	PLL. DO	I	PLL IC DO signal	
34	PLL. ST	I	TUNER STEREO signal detect	L : STEREO
35	PLL. SD	I	TUNER SD signal detect	L : TUNED
36	RCV. CE	I	RECEIVER CHIP ENABLE signal	L : ENABLE
37	AVss	–	Analog GND	
38	RESET	I	u-Com reset	
39	EXTAL	I	Main clock (8MHz)	
40	XTAL	–	Main clock (8MHz)	
41	Vss	–	u-Com GND	
42	TX	–	Unused	
43	TEX	I	GND	
44	Vdd	–	+5V	
45	Vfdp	–	-33V	
46	SEL. ST1	O	TC9162AF/63AF/64AF strobe1	H : LATCH
47	PLL. DT	O	PLL IC DATA signal output	
48	PLL. CK	O	PLL IC CLOCK signal output	
49	PLL. CE	O	PLL IC CE signal output	
50	T. MUTE	O	Tuner mute control	L : MUTE ON
51	A. MUTE	O	Output mute control	L : MUTE ON
52	SW. MUTE	O	SUB WOOFER mute control	L : MUTE ON
53	10dB. ATT	O	VOLUME 10dB ATTENUATOR control	L : ATT ON
54	VOL. DT	O	VOLUME IC (M62446SP) data control	
55	VOL. CK	O	VOLUME IC (M62446SP) clock control	H : active
56	VOL. ST	O	VOLUME IC (M62446SP) strobe control	H : active
57	VCR. MUTE	O	VIDEO IC (NJU2279D) cont2/4 control	L : mute on
58	VCR. A	O	VIDEO IC (NJU2279D) cont1 control	H/L : static
59	VCR. B	O	VIDEO IC (NJU2279D) cont3 control	H/L : static
60	FA. RLY	O	Front SP. A relay control	H : relay ON
61	FB. RLY	O	Front SP. B relay control	H : relay ON
62	C. RLY	O	Center SP. relay control	H : relay ON
63	S. RLY	O	Surround SP. relay control	H : relay ON

## CIRCUIT DESCRIPTION

Pin No.	Pin name	I/O	Description	Active
64	POWER. RLY	O	Power relay control	H : relay ON
65	STANDBY. LED	O	STANDBY LED control	H : relay ON L : LED ON
66, 67	-	O	Unused	
68	SAP. LED1	O	SAP LED1	L : LED ON
69	SAP. LED2	O	SAP LED2	L : LED ON
70	SAP. LED3	O	SAP LED3	L : LED ON
71	PACK_CTL	O	VIDEO MUTE (M type)	L : MUTE ON
72	-	O	Unused	
73	EMPHASIS	O	TUNER EMPHASIS (M type)	H : 100 /10k L : 50k/9k
74~81	P1/KS7~P8/KS0	O	FL (11-MT-116GK) SEG 1~8 & KEY SCAN 7~0	
82~88	P9~P15	O	FL (11-MT-116GK) SEG 9~15	
89	Vdd	O	u-Com +5V power supply	
90, 91	P16, P17	O	FL (11-MT-116GK) SEG 16, 17	
92~100	G1~G9	O	FL (11-MT-116GK) GRID 1~9	

### 7. Control list for the switch and the port

(1) Input selector (BU4066BCF)

X09, IC17			
	IC PORT	⑩, ⑪	③, ④
	Surround	⑧, ⑨	②, ①
No.	Input Selector	MD/TAPE REC	LSch/RSch
1	MD/TAPE	X	X
2	6ch INPUT	O	O
3	OTHERS	O	X

(0 : SW OFF/1 : SW ON)

(2) Electric volume (M62446FP)

X09, IC9					
	IC PORT	⑰	⑱	⑲	⑳
	Surround	out1	out2	out3	out4
No.	Input Selector	LSch/RSch	LSch/RSch	----	----
1	MD/TAPE	X	X	X	X
2	6ch INPUT	O	O	X	X
3	OTHERS	X	X	X	X

(0 : SW OFF/1 : SW ON)

(3) Input selector (TC9164AF)

X09, IC6															
	IC CHANNEL	Lch	Rch	Lch	Rch	Lch	Rch	Lch	Rch	Lch	Rch	Lch	Rch	Lch	Rch
	IC PORT	S1	S2	S3	S4	S5	S6	S7	S8						
No.	Input Selector	TUNER	PHONO	CD	MD/TAPE/PLAY	VIDEO1 PLAY	VIDEO1 REC	VIDEO2	MONITOR						
1	PHONO	X	O	X	X	X	O	X	X						
2	CD	X	X	O	X	X	O	X	X						
3	VIDEO2	X	X	X	X	X	X	O	X						
4	MONITOR ON	now condition	now condition	now condition	now condition	now condition	X	O(0dB selector)	O(-6dB selector)						
5	TAPE/MD	X	X	X	O	X	O	X	X						
6	VIDEO1	X	X	X	X	O	O	X	X						
7	TUNER	O	X	X	X	X	O	X	X						
8	6ch INPUT	X	X	X	X	X	O	X	X						

(0 : SW OFF/1 : SW ON)

(4)Surr. Mode selector(TC9162AF)

X09, IC7																
	IC CHANNEL	Lch	Rch	Lch	Rch	Lch	Rch	Lch	Rch	Lch	Rch	Lch	Rch	Lch	Rch	---
	IC PORT	② S1 ⑲	③ S2 ⑳	⑤ S3 ㉑	⑥ S4 ㉒	⑧ S5 ㉓	⑨ S6 ㉔	⑪ S7 ㉕								
	Surround	prologic	6ch input	prologic	6ch input	prologic	6ch input	6ch input								
No.	Speaker	FLch	FRch	FLch	FRch	SWch	Cch	SWch	Cch	LSch	RSch	LSch	RSch	---	---	---
1	DOLBY PROLOGIC	O		X		O	O	X		O		X		X		---
2	DOLBY 3STEREO	O		X		O	O	X		X		X		X		---
3	DSP LOGIC	O (2ch selector)		O (4ch selector)		O	O	X		O		O (4ch selector)		X		---
4	STEREO	X		O		O	X	X		X		X		X		---
5	SOURCE DIRECT	X		X		O	X	X		X		X		X		---
6	6ch INPUT	O		O		X	X	O		X		X		O		---

(0 : SW OFF/1 : SW ON)

### 8. Contents of the speaker setting

(VR-207 series only)

SUB WOOFER	YES/NO					
	LARGE		NORMAL		NO	
CENTER SP.	YES	NO	YES	NO	YES	NO
SURROUND SP.						
CENTER MODE (PRO LOGIC)	WIDEBAND		NORMAL		PHANTOM	

## ADJUSTMENT

No.	ITEM	INPUT SETTINGS	OUTPUT SETTINGS	TUNER SETTINGS	ALIGNMENT POINTS	ALIGN FOR	FIG.
<b>FM SECTION : EXCEPT E,T,Q type      SELECTOR : FM</b>							
1	DISTORTION (STEREO)	(C) 98.0MHz 1kHz, ±68.25kHz dev. Selector : L or R Pilot : ±6.75kHz dev. 70dBf (ANT. input)	(B)	98.0MHz	IFT (TUNER UNIT: A1)	Minimum distortion (L or R)	(a)
2	TUNING LEVEL	(A) 98.0MHz MONO 1kHz, ±75kHz dev. 25dBf (ANT. input)	(B)	MONO 98.0MHz	VR1 (TUNER UNIT)	Adjust VR1 and stop at the point where ED51 (TUNED) goes on.	(a)
<b>TV SECTION : VR-257 (X04-) only      SELECTOR : TV</b>							
1	SEPARATION	(D) TV 3ch : 65.75MHz or TV 4ch : 71.75MHz STEREO AF : 3kHz, NR ON 70dBf.	(B)	TV 3ch or TV 4ch	VR1 (HTB TV UNIT)	Minimum crosstalk	(a)
<b>FM SECTION : E,T,Q type only      SELECTOR : FM      ※Adjust NO.1 and NO.2 repeat.</b>							
1	DISCRIMINATOR	(A) 98.0MHz 1kHz, ±40kHz dev. 70dBf (ANT. input)	Connect a DC voltmeter between CN2 ① and CN2 ② (TUNER UNIT)	MONO 98.0MHz	L4 (TUNER UNIT)	0V	(a)
2	DISTORTION (MONO)	(A) 98.0MHz 1kHz, ±40kHz dev. MONO 70dBf (ANT. input)	(B)	MONO 98.0MHz	L5 (TUNER UNIT)	Minimum distortion	(a)
3	DISTORTION (STEREO)	(C) 98.0MHz 1kHz, ±40kHz dev. Selector : L or R Pilot : ±6kHz dev. 70dBf (ANT. input)	(B)	AUTO 98.0MHz	IFT (TUNER UNIT : A1)	Minimum distortion (L or R)	(a)
4	TUNING LEVEL	(A) 98.0MHz MONO 1kHz, ±40kHz dev. 25dBf (ANT. input)	(B)	MONO 98.0MHz	VR1 (TUNER UNIT)	Adjust VR1 and stop at the point where ED51 (TUNED) goes on.	(a)

### SYSTEM CONNECTIONS

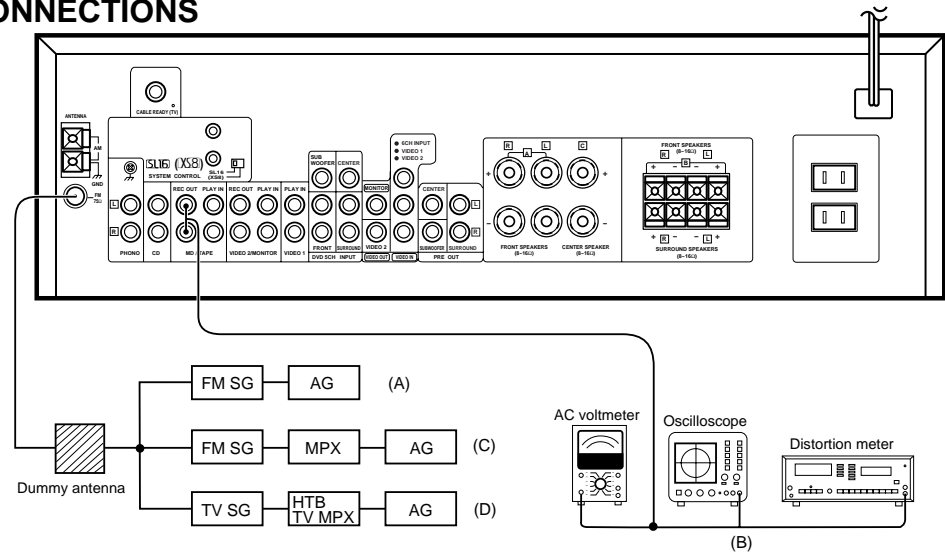

# PC BOARD (Component side view)

## 1 TUNER UNIT

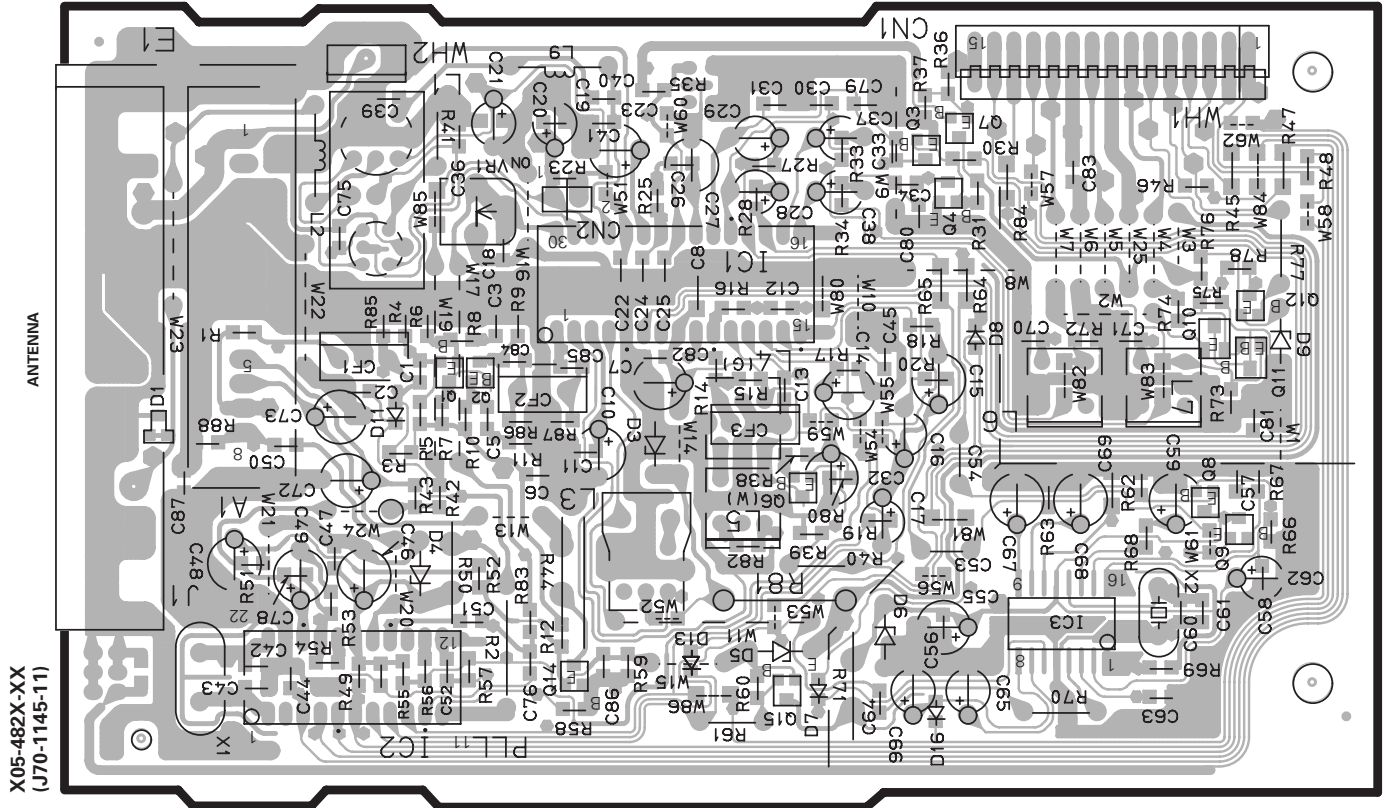

## 4 POWER SUPPLY UNIT

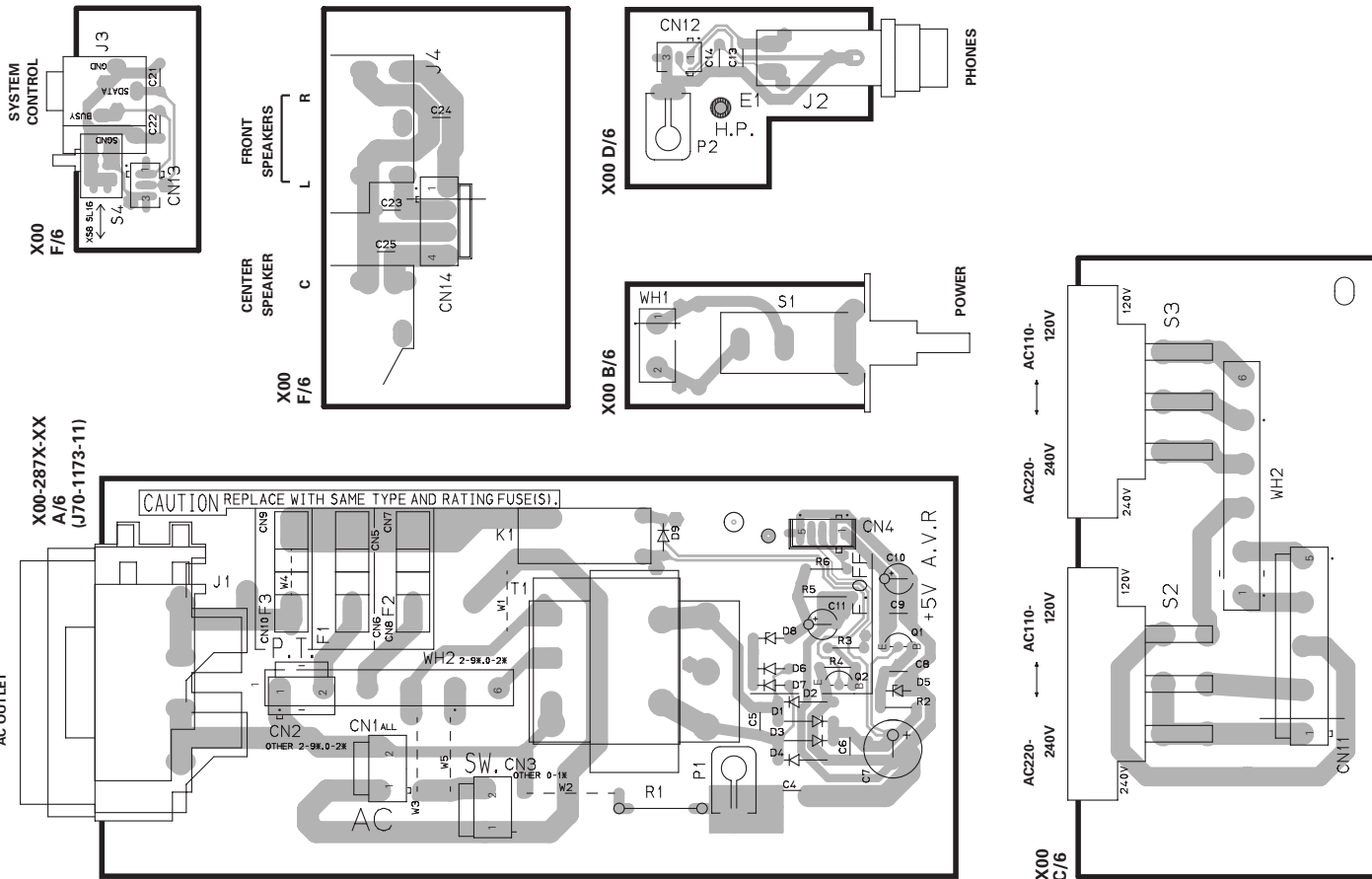

# PC BOARD(Component side view)

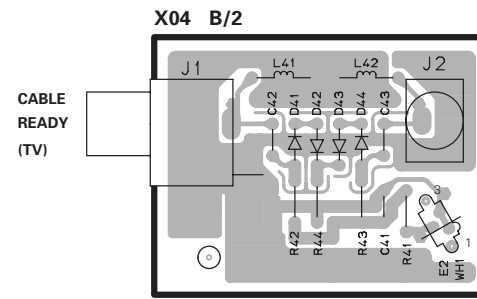

X04-1320-10 A/2 (J70-1165-01)

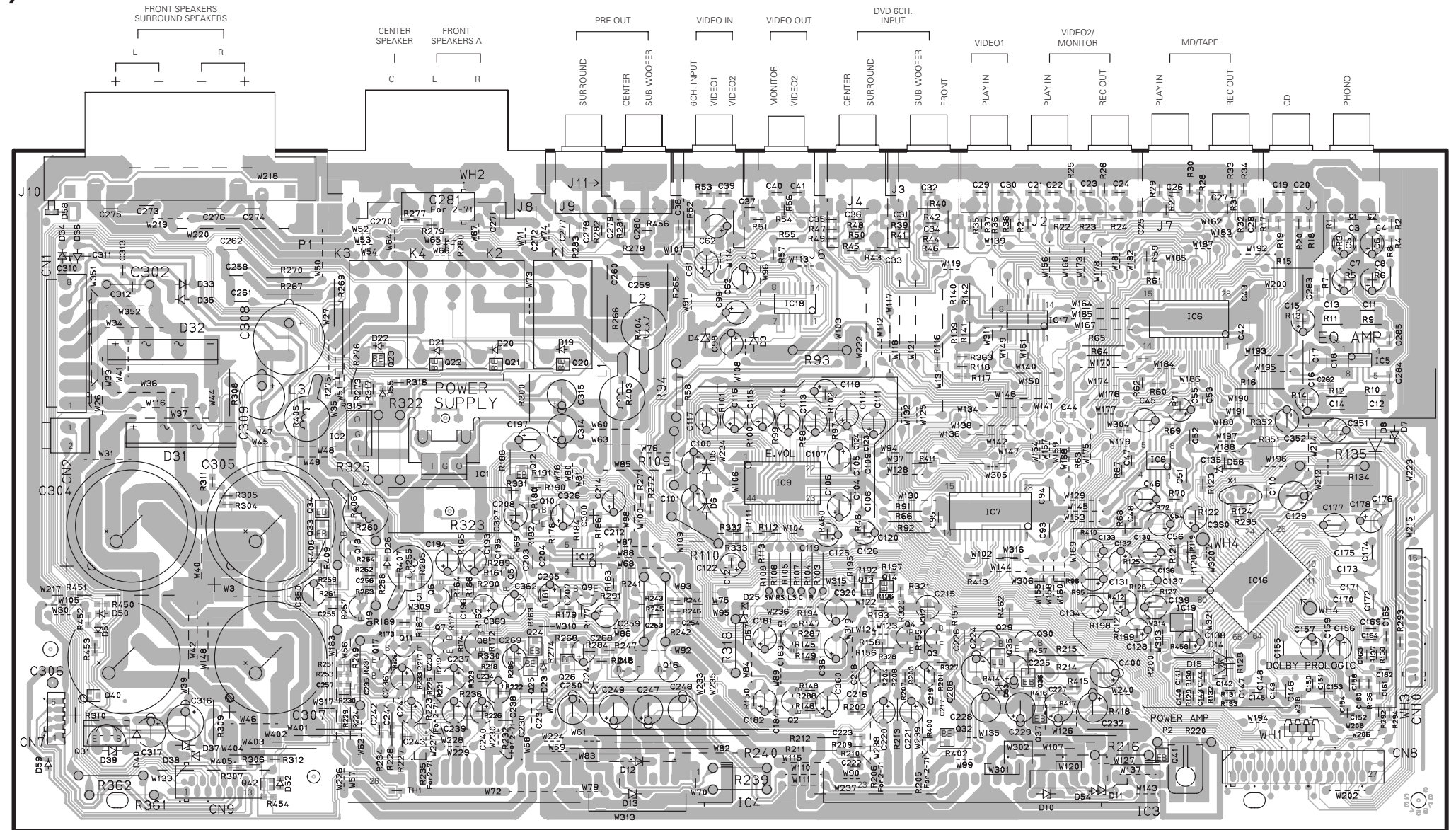
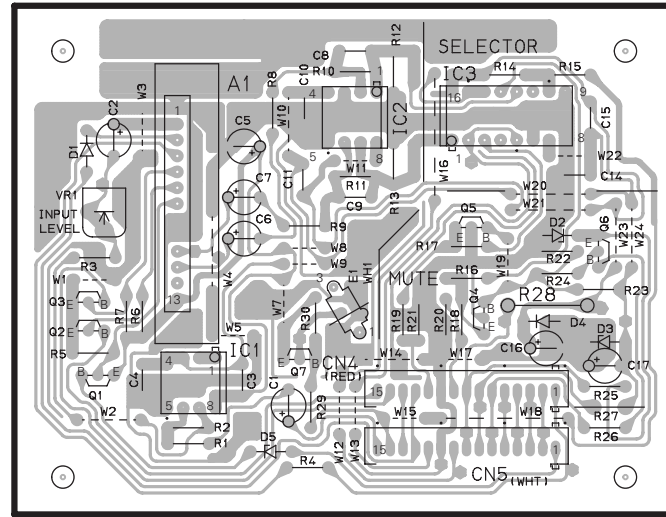

X09-490X-XX A/3 (J70-1172-21)

X09 C/3

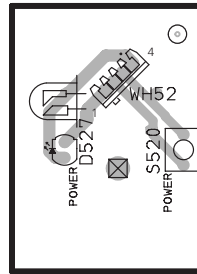

X09 B/3

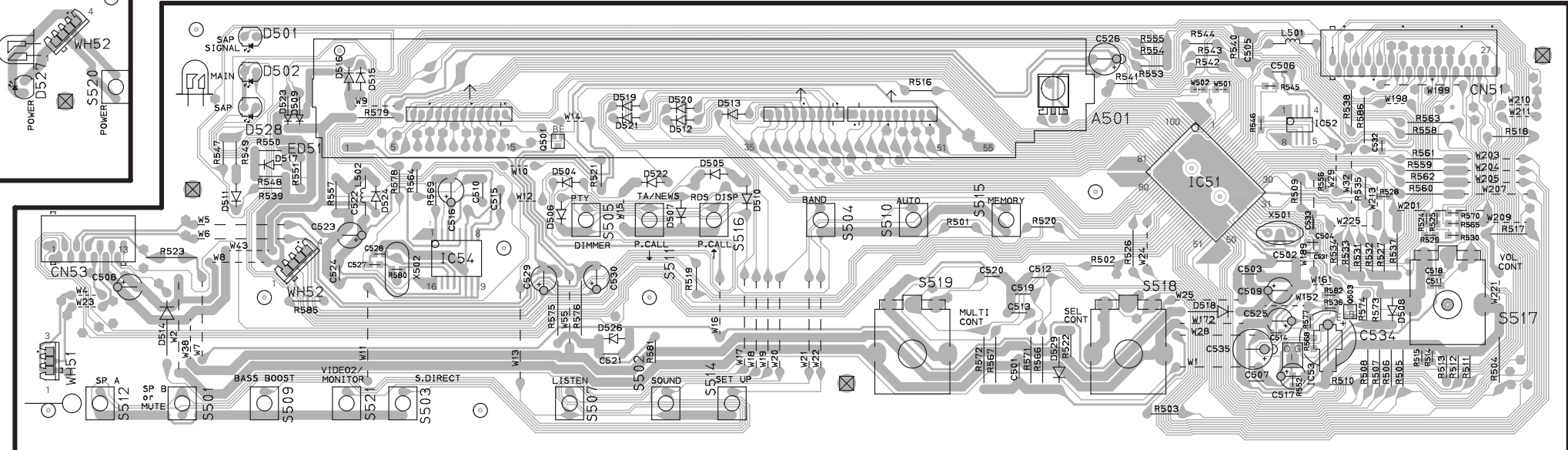

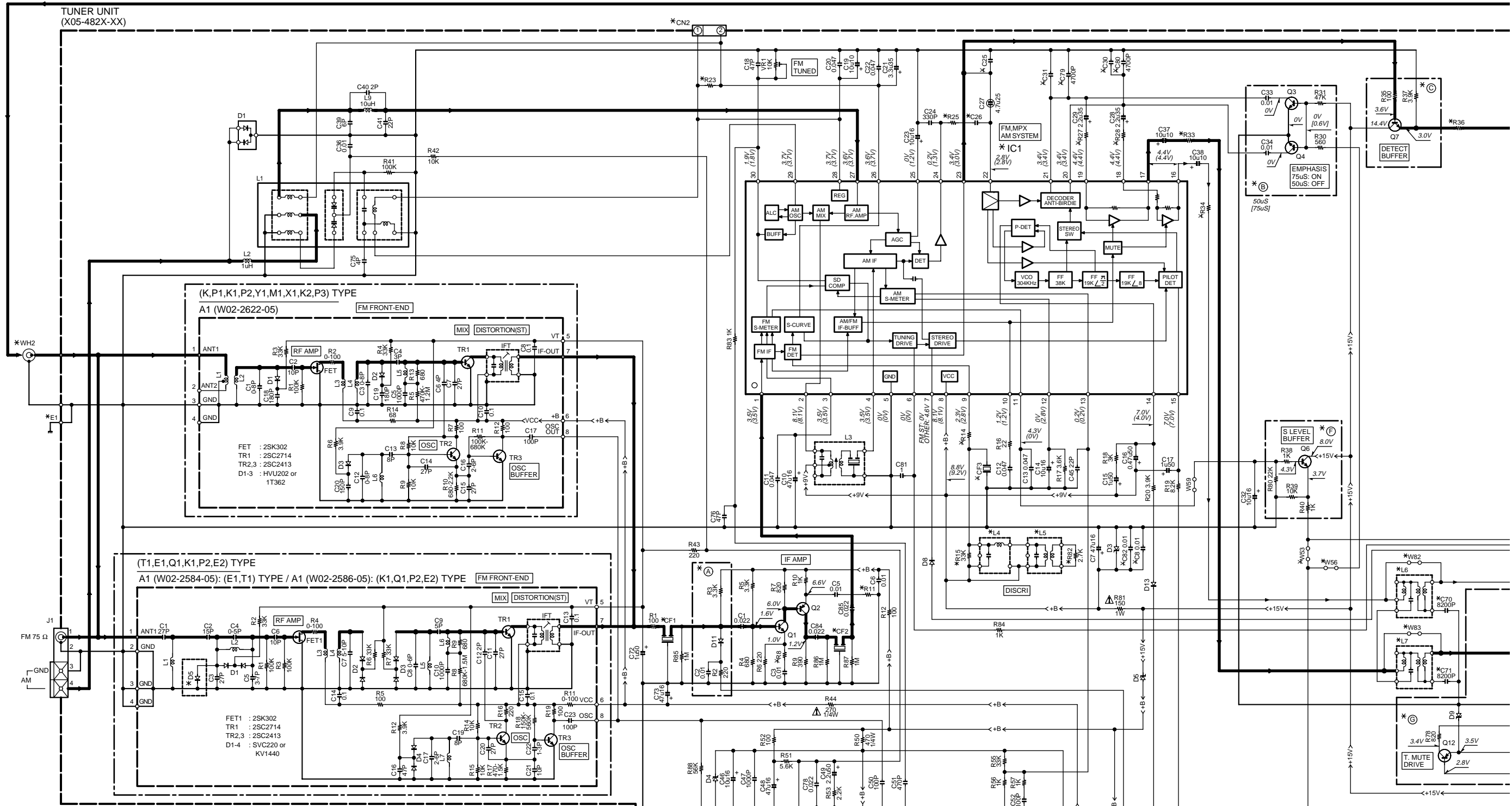

DESTINATION		UNIT No.	E1	CF1.2	CF3	R8	R11	R14	R15	R23	R25	R27	R28	R33	R34	R36	R72	C8	C25	C26	C30	C70.71	L4-7	CN1	CN2	IC1	A1	Ⓐ	Ⓑ	Ⓒ	Ⓓ	Ⓔ	WH1.2	WS3.58	WS8.86	WS6	WS2.83	
GENERAL MARKET	F1	0-21	F10-1108-04	L72-0531	YES	33	33	270	NO	3.3K	18K	8.2K	1K	NO	8.2K	YES	390P	0.022	0.022	NO	NO	NO	NO	NO	LA1838	W02-2622	NO	YES	NO	NO	NO	NO	NO	NO	YES	YES		
AUSTRALIA	X1	0-71	F10-1108-04	L72-0531	YES	33	33	270	NO	3.3K	18K	8.2K	1K	NO	8.2K	YES	390P	0.022	0.022	NO	NO	NO	NO	NO	NO	LA1838	W02-2622	NO	YES	NO	NO	NO	NO	NO	NO	YES	YES	
U.K.	T1	2-71	F10-1109-04	L72-0536	NO	10	22	100	YES	15K	27K	4.3K	1K	1K	3.9K	NO	180P	0.018					YES	YES	YES	LA1837	W02-2584	YES	NO	NO	NO	NO	NO	NO	NO	NO	NO	
EUROPE	E1																																					

DESTINATION		UNIT No.	E1	CF1.2	CF3	R8	R11	R14	R15	R23	R25	R27	R28	R33	R34	R36	R72	C8	C25	C26	C30	C70.71	L4-7	CN1	CN2	IC1	A1	Ⓐ	Ⓑ	Ⓒ	Ⓓ	Ⓔ	WH1.2	WS3.58	WS8.86	WS6	WS2.83	
GENERAL MARKET	M1	0-21	F10-1108-04	L72-0531	YES	33	33	270	NO	3.3K	18K	8.2K	1K	NO	8.2K	YES	390P	0.022	0.022	NO	NO	NO	NO	NO	NO	LA1838	W02-2622	NO	YES	NO	NO	NO	NO	NO	NO	NO	YES	YES
AUSTRALIA	X1	0-71	F10-1108-04	L72-0531	YES	33	33	270	NO	3.3K	18K	8.2K	1K	NO	8.2K	YES	390P	0.022	0.022	NO	NO	NO	NO	NO	NO	LA1838	W02-2622	NO	YES	NO	NO	NO	NO	NO	NO	NO	YES	YES
U.K.	T1	2-71	F10-1109-04	L72-0536	NO	10	22	100	YES	15K	27K	4.3K	1K	1K	3.9K	NO	180P	0.018					YES	YES	YES	LA1837	W02-2584	YES	NO	NO	NO	NO	NO	NO	NO	NO	NO	NO
EUROPE	E1																																					

DESTINATION		UNIT No.	E1	CF1.2	CF3	R8	R11	R14	R15	R23	R25	R27	R28	R33	R34	R36	R72	C8	C25	C26	C30	C70.71	L4-7	CN1	CN2	IC1	A1	Ⓐ	Ⓑ	Ⓒ	Ⓓ	Ⓔ	WH1.2	WS3.58	WS8.86	WS6	WS2.83		
GENERAL MARKET	M1	0-21	F10-1108-04	L72-0531	YES	33	33	270	NO	3.3K	18K	8.2K	1K	NO	8.2K	YES	390P	0.022	0.022	NO	NO	NO	NO	NO	NO	LA1838	W02-2622	NO	YES	NO	NO	NO	NO	NO	NO	NO	NO	YES	YES
AUSTRALIA	X1	0-71	F10-1108-04	L72-0531	YES	33	33	270	NO	3.3K	18K	8.2K	1K	NO	8.2K	YES	390P	0.022	0.022	NO	NO	NO	NO	NO	NO	LA1838	W02-2622	NO	YES	NO	NO	NO	NO	NO	NO	NO	NO	YES	YES
U.K.	T1	2-71	F10-1109-04	L72-0536	NO	10	22	100	YES	15K	27K	4.3K	1K	1K	3.9K	NO	180P	0.018					YES	YES	YES	LA1837	W02-2586	YES	NO	NO	NO	NO	NO	NO	NO	NO	NO	NO	NO
EUROPE	E1																																						

DESTINATION		UNIT No.	E1	CF1.2	CF3	R8	R11	R14	R15	R23	R25	R27	R28	R33	R34	R36	R72	C8	C25	C26	C30	C70.71	L4-7	CN1	CN2	IC1	A1	Ⓐ	Ⓑ	Ⓒ	Ⓓ	Ⓔ	WH1.2	WS3.58	WS8.86	WS6	WS2.83			
GENERAL MARKET	M1	0-21	F10-1108-04	L72-0531	YES	33	33	270	NO	3.3K	18K	8.2K	1K	NO	8.2K	YES	390P	0.022	0.022	NO	NO	NO	NO	NO	NO	LA1838	W02-2622	NO	YES	NO	NO	NO	NO	NO	NO	NO	NO	NO	YES	YES
AUSTRALIA	X1	0-71	F10-1108-04	L72-0531	YES	33	33	270	NO	3.3K	18K	8.2K	1K	NO	8.2K	YES	390P	0.022	0.022	NO	NO	NO	NO	NO	NO	LA1838	W02-2622	NO	YES	NO	NO	NO	NO	NO	NO	NO	NO	NO	YES	YES
U.K.	T1	2-71	F10-1109-04	L72-0536	NO	10	22	100	YES	15K	27K	4.3K	1K	1K	3.9K	NO	180P	0.018					YES	YES	YES	LA1837	W02-2586	YES	NO	NO	NO	NO	NO	NO	NO	NO	NO	NO	NO	NO
EUROPE	E1																																							





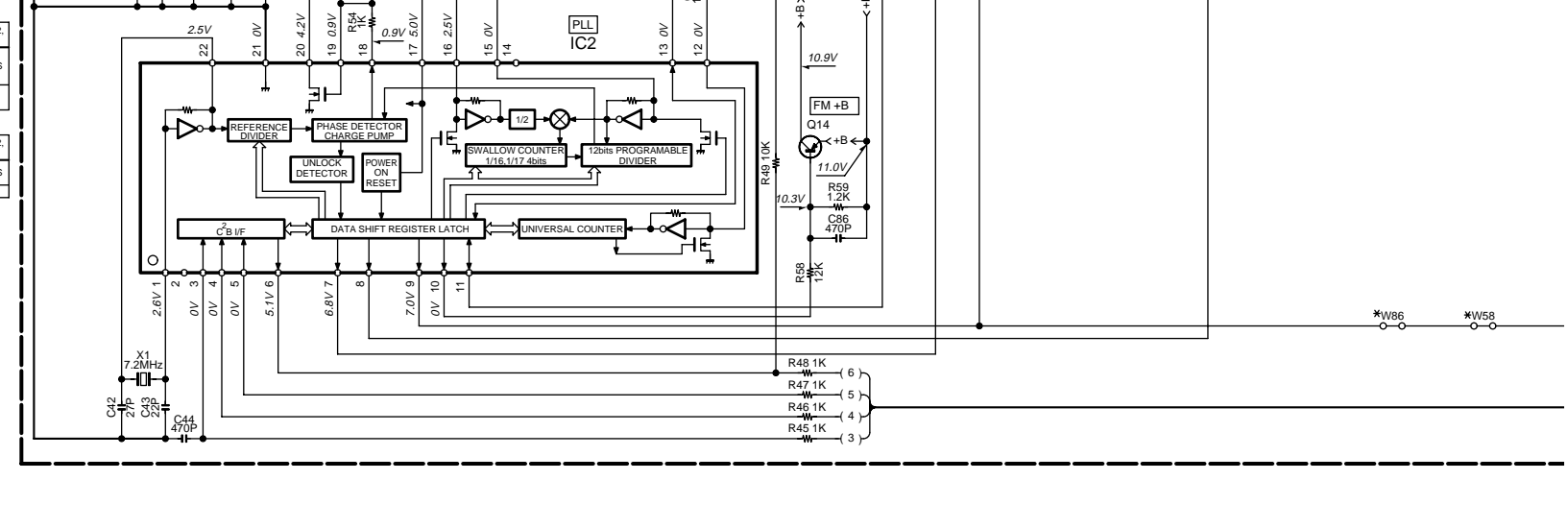

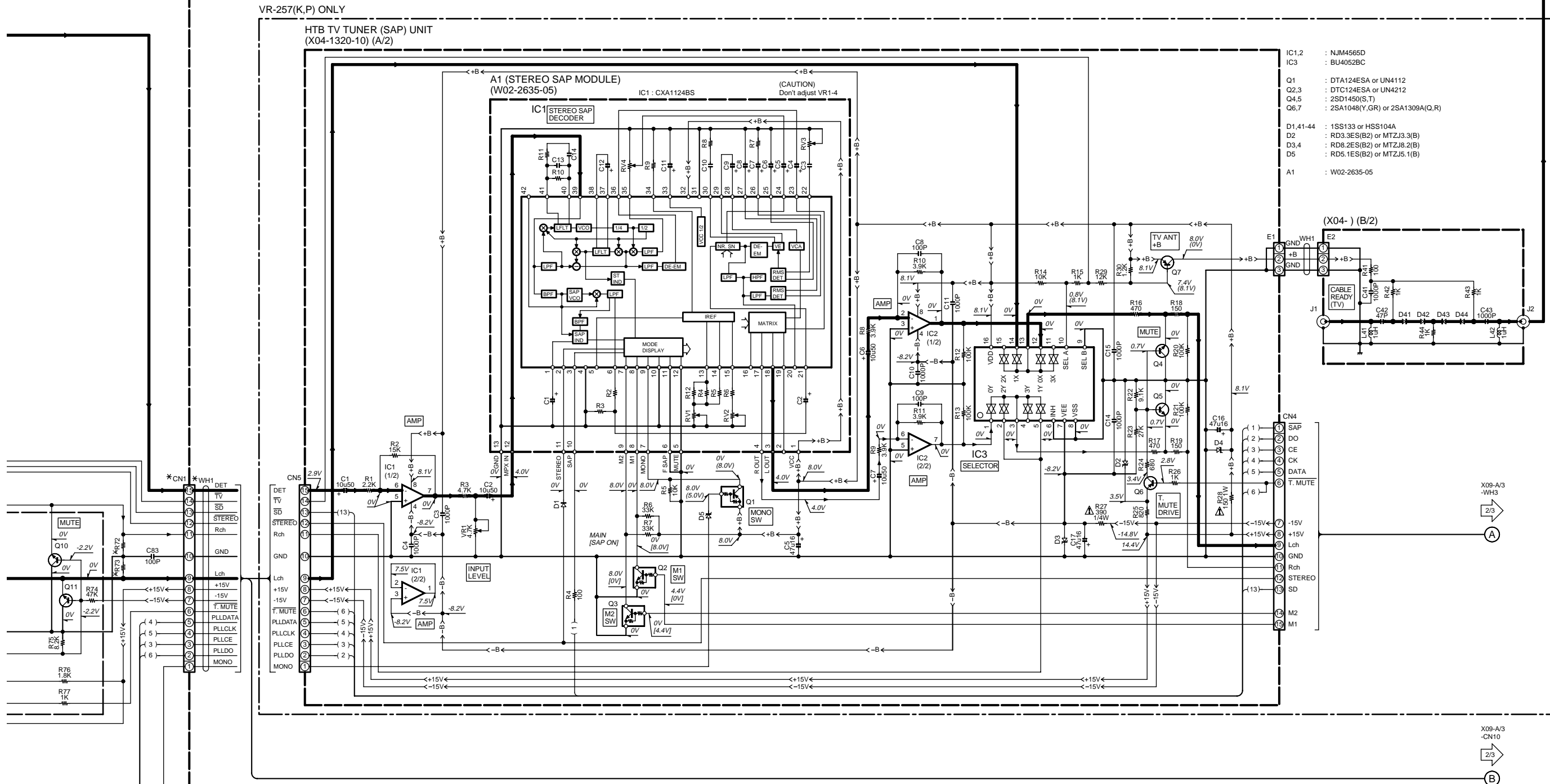
- IC1,2 : NJM4565D
- IC3 : BU4052BC
- Q1 : DTA124ESA or UN4112
- Q2,3 : DTC124ESA or UN4212
- Q4,5 : 2SD1450(S,T)
- Q6,7 : 2SA1048(Y,GR) or 2SA1309A(Q,R)
- D1,41-44 : 1SS133 or HSS104A
- D2 : RD3.3ES(B2) or MTZJ3.3(B)
- D3,4 : RD8.2ES(B2) or MTZJ8.2(B)
- D5 : RD5.1ES(B2) or MTZJ5.1(B)
- A1 : W02-2635-05

- IC1 : \*
- IC2 : LC72131
- Q1,3,4,6,7 : 2SC4081(R,S) or 2SC4116(Y,GR)
- Q2,12,14 : 2SA1576A(R,S) or 2SA1586(Y,GR)
- Q10,11 : 2SD1757K
- D1 : DA204V or MA143A or 1SS302
- D3 : RD8.2ES(B2) or MTZJ8.2(B)
- D4 : RD5.1ES(B2) or MTZJ5.1(B)
- D5 : RD2.7ES(B2) or MTZJ2.7(B)
- D8,10,11,13 : MA111
- D9 : RD3.3ES(B2) or MTZJ3.3(B)
- A1 : \*

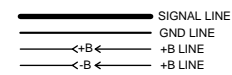

The DC voltage is an actual reading measured with a high impedance type voltmeter as the AM/FM signal generator is specified to the conditions as shown in the list below. The measurement value may vary depending on the measuring instruments used or on the product. The value shown in ( ) is actual reading measured in the AM mode.

MODE	CARRIER	MODULATION		ANT INPUT
		FREQUENCY	DEVIATION	
FM	98MHz	1kHz	STEREO 67.5kHz 7.5kHz(Pilot)	60dB
AM	1000(999)kHz	400Hz	MONO 30% MOD	60dB

VR-205/206/207/255/257 (K) (1/3)  
 KRF-V5010/V6010/V7010/V5010W/V6010W/V7010W (E) (1/3)

**CAUTION:** For continued safety, replace safety critical components only with manufacturer's recommended parts (refer to parts list).  $\Delta$  indicates safety critical components. For continued protection against risk of fire, replace only with same type and rating fuse(s). To reduce the risk of electric shock, leakage-current or resistance measurements shall be carried out (exposed parts are acceptably insulated from the supply circuit) before the appliance is returned to the customer.

KRF-V5010/V6010/V7010/VR-205/206/207/255/257

- IC1 : TA7815SB
  - IC2 : TA79015SB
  - IC3 : \*
  - IC4 : \*
  - IC5 : NJM4580ED
  - IC6 : TC9164AF
  - IC7 : TC9162AF
  - IC8,12 : NJM4565MD
  - IC9 : M62446FP
  - IC16 : M62460AFP
  - IC17 : BU4066BCF
  - IC18 : NJM2279M
  - IC19 : M5278L05M
- Q1-11 : 2SC2878(B)
  - Q12,40,42 : 2SC4213(B)
  - Q13,14 : 2SA1585(V,GR) or 2SA1161(M5,M6)
  - Q15-19 : 2SC1845(F,E)
  - Q20-23 : DTC123ZUA
  - Q24,25,32-34,36,37 : 2SC3722K(R,S)
  - Q26,35 : 2SA1255
  - Q29 : 2SC2631(S,T)
  - Q30 : 2SA1123(S,T)
  - Q31 : \*
  - Q41 : TH1 : PTH9C42BD471Q
- D3,4,7 : MTZJ5.1(B) or RD5.1ES(B2)
  - D5,6 : MTZJ6.8(B) or RD6.8ES(B2)
  - D8 : MTZJ11(B) or RD11ES(B2)
  - D10,12,13 : MTZJ8.2(B) or RD8.2ES(B2)
  - D11,56 : MTZJ7.5(B) or RD7.5ES(B2)
  - D14,15 : MTZJ10(B) or RD10ES(B2)
  - D19-23,26,50-55,59 : MA111
  - D24 : MTZJ4.7(B) or RD4.7ES(B2)
  - D25 : MTZJ3.3(B) or RD3.3ES(B2)
  - D31,32 : D4SB120UF03
  - D33-36 : S5888B(TP5)
  - D37,38 : MTZJ16(B) or RD16ES(B2)
  - D39,40 : MTZJ18(B) or RD18ES(B2)

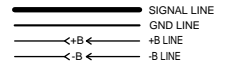

IC18 I/O TABLE

INPUT	MONITOR	VIDEO REC	V-A	V-B	MUTE
VIDEO1		X	L	L	L
VIDEO2			L	H	H
Sch INPUT			H	H	H

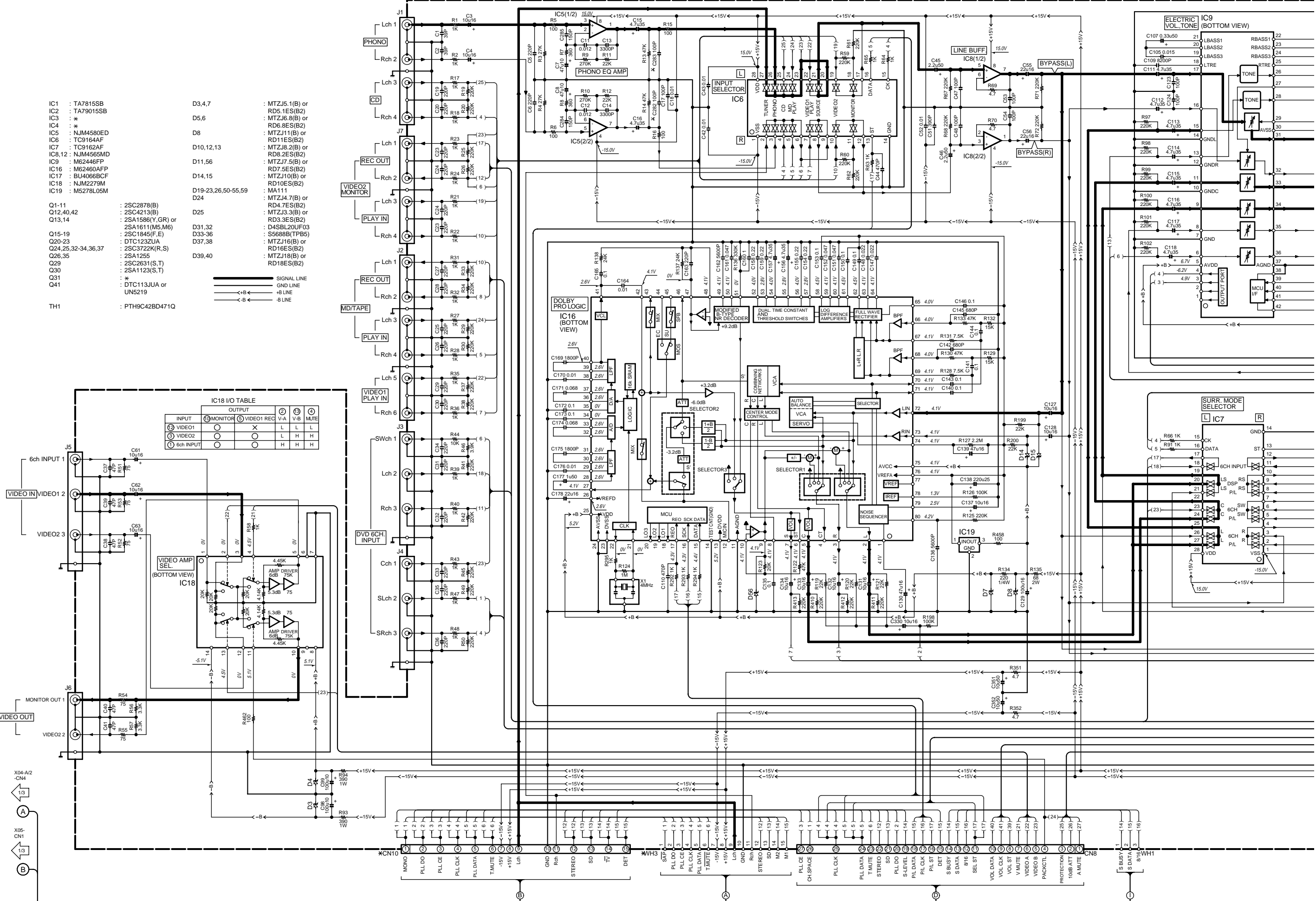

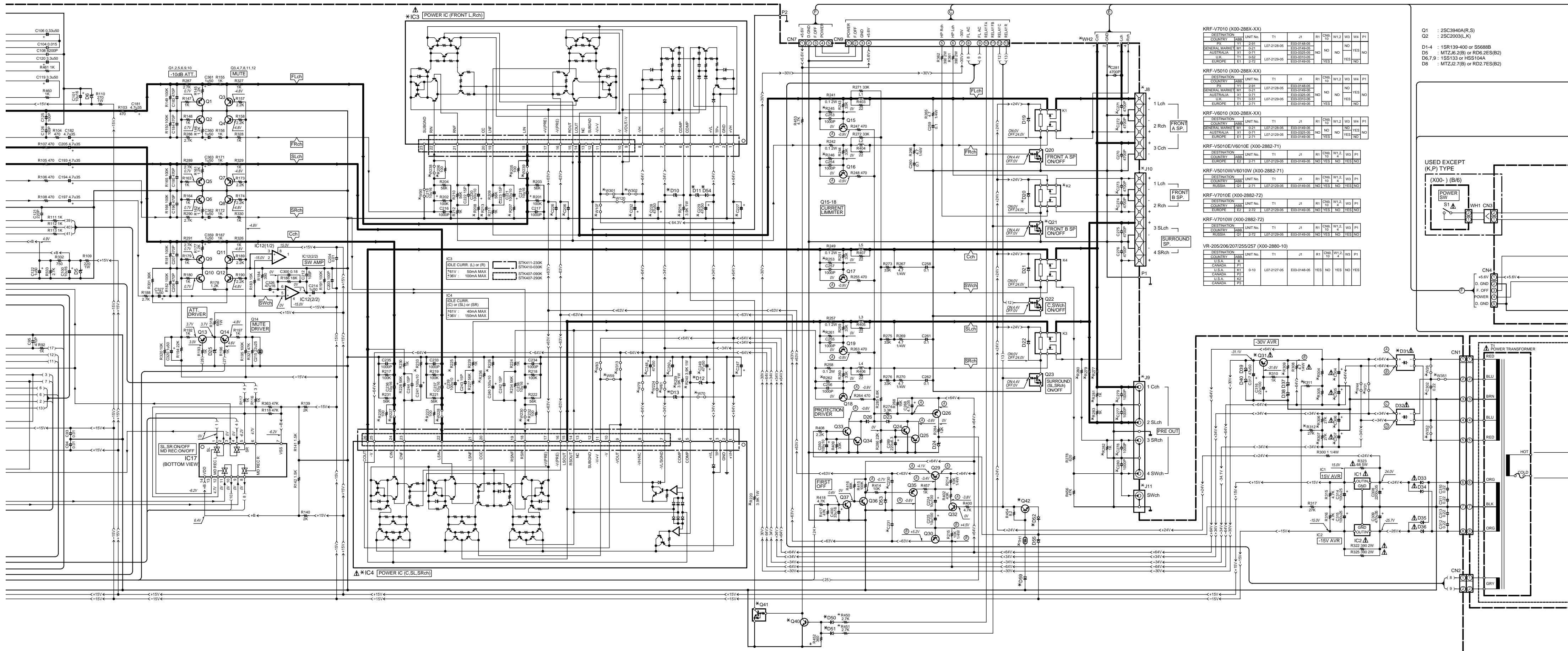

KRF-V7010 (X00-288X-XX)

DESTINATION	UNIT No.	T1	J1	R1	CN8	W1,2	W3	W4	P1
COUNTRY	ABS	Y1	2-91	L07-2129-05	E03-0148-05	NO	NO	NO	NO
GENERAL MARKET	MT	0-21	L07-2129-05	E03-0149-05	NO	NO	NO	NO	NO
AUSTRALIA	X1	0-71	L07-2129-05	E03-0205-05	NO	NO	NO	NO	NO
U.S.	T1	0-51	L07-2129-05	E03-0310-05	YES	NO	NO	NO	NO
EUROPE	E1	2-71	L07-2129-05	E03-0149-05	YES	NO	NO	NO	NO

KRF-V5010 (X00-288X-XX)

DESTINATION	UNIT No.	T1	J1	R1	CN8	W1,2	W3	W4	P1
COUNTRY	ABS	Y1	2-91	L07-2129-05	E03-0148-05	NO	NO	NO	NO
GENERAL MARKET	MT	0-21	L07-2129-05	E03-0149-05	NO	NO	NO	NO	NO
AUSTRALIA	X1	0-71	L07-2129-05	E03-0205-05	NO	NO	NO	NO	NO
U.S.	T1	0-51	L07-2129-05	E03-0310-05	YES	NO	NO	NO	NO
EUROPE	E1	2-71	L07-2129-05	E03-0149-05	YES	NO	NO	NO	NO

KRF-V6010 (X00-288X-XX)

DESTINATION	UNIT No.	T1	J1	R1	CN8	W1,2	W3	W4	P1
COUNTRY	ABS	Y1	2-91	L07-2129-05	E03-0148-05	NO	NO	NO	NO
GENERAL MARKET	MT	0-21	L07-2129-05	E03-0149-05	NO	NO	NO	NO	NO
AUSTRALIA	X1	0-71	L07-2129-05	E03-0205-05	NO	NO	NO	NO	NO
U.S.	T1	0-51	L07-2129-05	E03-0310-05	YES	NO	NO	NO	NO
EUROPE	E1	2-71	L07-2129-05	E03-0149-05	YES	NO	NO	NO	NO

KRF-V5010E/V6010E (X00-2882-71)

DESTINATION	UNIT No.	T1	J1	R1	CN8	W1,2	W3	W4	P1
COUNTRY	ABS	E2	2-71	L07-2129-05	E03-0149-05	NO	NO	NO	NO
RUSSIA	Q1	2-71	L07-2129-05	E03-0149-05	NO	NO	NO	NO	NO

KRF-V5010W/V6010W (X00-2882-71)

DESTINATION	UNIT No.	T1	J1	R1	CN8	W1,2	W3	W4	P1
COUNTRY	ABS	E2	2-71	L07-2129-05	E03-0149-05	NO	NO	NO	NO
RUSSIA	Q1	2-71	L07-2129-05	E03-0149-05	NO	NO	NO	NO	NO

KRF-V7010E (X00-2882-72)

DESTINATION	UNIT No.	T1	J1	R1	CN8	W1,2	W3	W4	P1
COUNTRY	ABS	E2	2-72	L07-2129-05	E03-0149-05	NO	NO	NO	NO
RUSSIA	Q1	2-72	L07-2129-05	E03-0149-05	NO	NO	NO	NO	NO

KRF-V7010W (X00-2882-72)

DESTINATION	UNIT No.	T1	J1	R1	CN8	W1,2	W3	W4	P1
COUNTRY	ABS	E2	2-72	L07-2129-05	E03-0149-05	NO	NO	NO	NO
RUSSIA	Q1	2-72	L07-2129-05	E03-0149-05	NO	NO	NO	NO	NO

VR-205/206/207/255/257 (X00-2880-10)

DESTINATION	UNIT No.	T1	J1	R1	CN8	W1,2	W3	W4	P1
COUNTRY	ABS	0-10	L07-2127-05	E03-0148-05	YES	NO	YES	NO	YES
U.S.A.	R								
U.S.A.	K1								
U.S.A.	K2								
U.S.A.	P2								
U.S.A.	K3								
CANADA	P3								

- Q1 : 2SC3940A(R,S)
- Q2 : 2SC2003(L,K)
- D1-4 : 1SR139-400 or S5688B
- D5 : MTZJ6.2(B) or RDS.2ES(B2)
- D6,7,9 : 1SS133 or HSS104A
- D8 : MTZJ2.7(B) or RD2.7ES(B2)

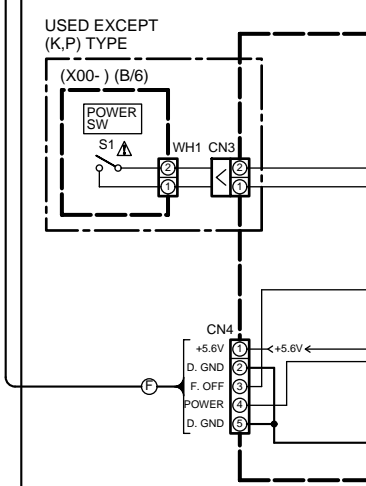

DC VOLTAGE FOR IC3

PIN NO.	1	2	3	4	5	6	7	8	9	10	11	12	13	14	15	16	17	18	19	20	21	22	23
STK411-230K	⊕12V	0V	36.7V	36.0V	27.8V	27.7V	⊕36.0V	⊕12V	35.7V	35.7V	35.7V	0V	0V	0V	0V	36.0V	37.2V	0V	0V	34.8V	0V	0V	0V
STK407-090K	⊕12V	0V	36.7V	36.0V	27.8V	27.7V	⊕36.0V	⊕12V	35.7V	35.7V	35.7V	0V	0V	0V	0V	36.0V	37.2V	0V	0V	34.8V	0V	0V	0V

DC VOLTAGE FOR IC4

PIN NO.	1	2	3	4	5	6	7	8	9	10	11	12	13	14	15	16	17	18	19	20	21	22	23	24	25	26
STK411-230K	⊕12V	0V	36.7V	36.0V	27.8V	27.7V	⊕36.0V	⊕12V	35.7V	35.7V	35.7V	0V	0V	0V	0V	36.0V	37.2V	0V	0V	34.8V	0V	0V	0V	0V	0V	0V
STK407-090K	⊕12V	0V	36.7V	36.0V	27.8V	27.7V	⊕36.0V	⊕12V	35.7V	35.7V	35.7V	0V	0V	0V	0V	36.0V	37.2V	0V	0V	34.8V	0V	0V	0V	0V	0V	0V

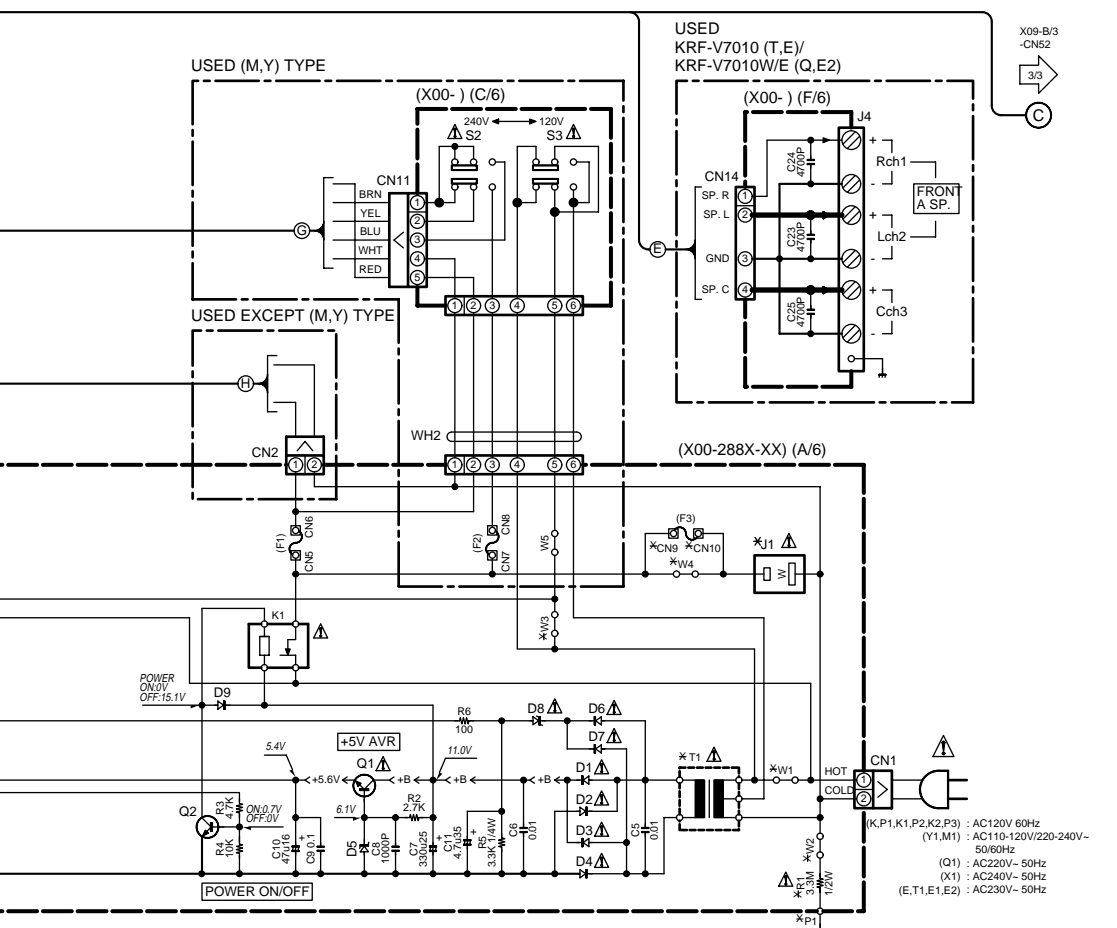

- VR-206 (K,P)
- VR-207 (K,P)
- VR-257 (K,P)
- KRF-V6010 (E,X)
- KRF-V6010W (Q)
- KRF-V6010E (E2)
- KRF-V7010 (E,T,X)
- KRF-V7010W (Q)
- KRF-V7010E (E2)

**VR-205/255 (X09-4900-10)**

DESTINATION	COUNTRY	ABB	UNIT No.	CN10	J8,9	J10	J11,12	WH2,3	W26,31,44,56,70,83,107,120,224,227,228,230,238,239,301,352-355	W59,61,79,90,227,228,230,238,239,301,351	IC3	IC4	Q21,40,41	Q31	D10-13,20,31,50,51,54	D52,59	R205,206,223,230,236,237,238,239,240,208,209	R207,208	R213,236	R216,220,239,240,281-283,306,307,312,450-454	R225,226,233	R245,246,253,261,262	R304,305,311	R309	R402	C206,226,230,231	C227,232,247,248	C228,229,249,250,273,274,277,280,282,283,302	C271,272	C304,305	K2	TH1	
U.S.A.	K																																
CANADA	PT																																
U.S.A.	K1		0-10	YES	YES	NO	(4P)	NO	YES	NO	STK407-090K	STK407-290K	NO	2SA1534A	NO			470	20K	430	39K	27K	4.7K/10W	56K	3900P50	47u50	YES	3300u50	NO	NO	NO		

**VR-206/207 (X09-4900-11)**

DESTINATION	COUNTRY	ABB	UNIT No.	CN10	J8,9	J10	J11,12	WH2,3	W26,31,44,56,70,83,107,120,224,302,313,352-355	W59,61,79,90,227,228,230,238,239,301,351	IC3	IC4	Q21,40,41	Q31	Q42	D10-13,20,31,50,51,54	D52,59	R205,206,223,230,236,237,238,239,240,208,209	R207,208	R213,236	R216,220,239,240,281-283,306,307,312,450-454	R225,226,233	R245,246,253,261,262	R277,278,280,305,311	R304,305,311	R309	R402	C206,226,230,231	C227,232,247,248	C228,229,249,250,271-274,277,280,282,283,302	C302	C304,305	C306,307	K2	TH1				
U.S.A.	K																																						
CANADA	PT		0-11	YES	YES	(8P)	NO	NO	NO	YES	STK411-230K or STK411-230D	STK410-030K or STK410-030D	YES	2SB1640	NO	YES	NO	NO	NO	330	33K	YES				300	24K	27K	51K	10K/10W	40K	3900P50	10u100	YES	NO	4700u75	3300u42	YES	NO

**VR-257 (X09-4900-12)**

DESTINATION	COUNTRY	ABB	UNIT No.	CN10	J8,9	J10	J11,12	WH2,3	W26,31,44,56,70,83,107,120,224,302,313,352-355	W59,61,79,90,227,228,230,238,239,301,351	IC3	IC4	Q21,40,41	Q31	Q42	D10-13,20,31,50,51,54	D52,59	R205,206,223,230,236,237,238,239,240,208,209	R207,208	R213,236	R216,220,239,240,281-283,306,307,312,450-454	R225,226,233	R245,246,253,261,262	R277,278,280,305,311	R304,305,311	R309	R402	C206,226,230,231	C227,232,247,248	C228,229,249,250,271-274,277,280,282,283,302	C271,272	C272,302	C304,305	C306,307	K2	TH1			
U.S.A.	K																																						
CANADA	PT		0-12	NO	YES	(8P)	NO	NO	NO	YES	STK411-230K or STK411-230D	STK410-030K or STK410-030D	YES	2SB1640	NO	YES	NO	NO	NO	330	33K	YES				300	24K	27K	51K	10K/10W	40K	3900P50	10u100	YES	NO	4700u75	3300u42	YES	NO

**KRF-V5010 (X09-490X-XX)**

DESTINATION	COUNTRY	ABB	UNIT No.	CN10	J8,11,12	J9	J10	WH2,3	W26,31,44,56,70,83,107,120,224,302,313,352-355	W59,61,79,90,227,228,230,238,239,301,351	IC3	IC4	Q21,40,41	Q31	Q42	D10-13,20,31,50,51,54	D52,59	R205,206,223,230,236,237,238,239,240,208,209	R207,208	R213,236	R216,220,239,240,281-283,306,307,312,450-454	R225,226,233	R245,246,253,261,262	R277,278,280,305,311	R304,305,311	R309	R402	C206,226,230,231	C227,232,247,248	C228,229,249,250,273,274,277,280,282,283,302	C271,272	C272,302	C304,305	C306,307	K2	TH1	
U.S.A.	K																																				
U.S.A.	K1		0-21	YES	YES	NO	(4P)	NO	NO	YES	STK411-230K or STK411-230D	STK410-030K or STK410-030D	YES	2SB1640	NO	YES	NO	NO	470	20K	NO	YES			430	39K	27K	4.7K/10W	56K	3900P50	47u50	NO	YES	NO	3300u50	NO	NO
EUROPE	E1		2-71	YES	YES	NO	(4P)	NO	NO	NO	NO	NO	NO	NO	NO	YES	620		430	33K	YES			300	24K	27K	51K	10K/10W	40K	3900P50	10u100	NO	YES	NO	3300u42	NO	NO

**KRF-V5010E (X09-4903-81)**

DESTINATION	COUNTRY	ABB	UNIT No.	CN10	J8,11,12	J9	J10	WH2,3	W26,31,44,56,70,83,107,120,224,302,313,352-355	W59,61,79,90,227,228,230,238,239,301,351	IC3	IC4	Q21,40,41	Q31	Q42	D10-13,20,31,50,51,54	D52,59	R205,206,223,230,236,237,238,239,240,208,209	R207,208	R213,236	R216,220,239,240,281-283,306,307,312,450-454	R225,226,233	R245,246,253,261,262	R277,278,280,305,311	R304,305,311	R309	R402	C206,226,230,231	C227,232,247,248	C228,229,249,250,273,274,277,280,282,283,302	C271,272	C272,302	C304,305	C306,307	K2	TH1
U.S.A.	K																																			
EUROPE	E2		3-81	YES	YES	NO	(4P)	NO	NO	YES	NO	STK407-090K	STK407-290K	NO	2SB1640	NO	NO	NO	NO	620	20K	560	39K	27K	4.7K/10W	56K	3900P50	47u50	NO	YES	3300u42	NO	NO	NO	NO	

**KRF-V5010W (X09-4903-81)**

DESTINATION	COUNTRY	ABB	UNIT No.	CN10	J8,11,12	J9	J10	WH2,3	W26,31,44,56,70,83,107,120,224,302,313,352-355	W59,61,79,90,227,228,230,238,239,301,351	IC3	IC4	Q21,40,41	Q31	Q42	D10-13,20,31,50,51,54	D52,59	R205,206,223,230,236,237,238,239,240,208,209	R207,208	R213,236	R216,220,239,240,281-283,306,307,312,450-454	R225,226,233	R245,246,253,261,262	R277,278,280,305,311	R304,305,311	R309	R402	C206,226,230,231	C227,232,247,248	C228,229,249,250,273,274,277,280,282,283,302	C271,272	C272,302	C304,305	C306,307	K2	TH1
U.S.A.	K																																			
RUSSIA	Q1		3-81	YES	YES	NO	(4P)	NO	NO	YES	NO	STK407-090K	STK407-290K	NO	2SB1640	NO	NO	NO	NO	620	20K	560	39K	27K	4.7K/10W	56K	3900P50	47u50	NO	YES	3300u42	NO	NO	NO	NO	

**KRF-V6010 (X09-490X-XX)**

DESTINATION	COUNTRY	ABB	UNIT No.	CN10	J8,9	J10	J11,12	WH2,3	W26,31,44,56,70,83,107,120,224,302,313,352-355	W59,61,79,90,227,228,230,238,239,301,351	IC3	IC4	Q21,40,41	Q31	Q42	D10-13,20,31,50,51,54	D52,59	R205,206,223,230,236,237,238,239,240,208,209	R207,208	R213,236	R216,220,239,240,281-283,306,307,312,450-454	R225,226,233	R245,246,253,261,262	R277,278,280,305,311	R304,305,311	R309	R402	R454	C206,226,230,231	C227,232,247,248	C228,229,249,250,273,274,277,280,282,283,302	C271,272	C281	C304,305	C306,307	K2	TH1	
U.S.A.	K																																					
EUROPE	E1		2-72	YES	YES	(8P)	NO	NO	NO	YES	STK411-230K or STK411-230D	STK410-030K or STK410-030D	YES	2SB1640	NO	YES	NO	NO	430	33K	YES				430	24K	27K	51K	10K/10W	40K	3900P50	10u100	YES	NO	4700u63	3300u35	YES	NO
GENERAL MARKET	M1		0-22	YES	YES	(8P)	NO	NO	NO	YES	STK411-230K or STK411-230D	STK410-030K or STK410-030D	YES	2SB1640	NO	YES	NO	NO	430	33K	YES				300	24K	27K	51K	10K/10W	40K	3900P50	10u100	NO	YES	4700u63	3300u35	YES	NO
AUSTRALIA	X1		0-22	YES	YES	(8P)	NO	NO	NO	YES	STK411-230K or STK411-230D	STK410-030K or STK410-030D	YES	2SB1640	NO	YES	NO	NO	430	33K	YES				300	24K	27K	51K	10K/10W	40K	3900P50	10u100	NO	YES	4700u63	3300u35	YES	NO

**KRF-V6010E (X09-4903-82)**

DESTINATION	COUNTRY	ABB	UNIT No.	CN10	J8,9	J10	J11,12	WH2,3	W26,31,44,56,70,83,107,120,224,302,313,352-355	W59,61,79,90,227,228,230,238,239,301,351	IC3	IC4	Q21,40,41	Q31	Q42	D10-13,20,31,50,51,54	D52,59	R205,206,223,230,236,237,238,239,240,208,209	R207,208	R213,236	R216,220,239,240,281-283,306,307,312,450-454	R225,226,233	R245,246,253,261,262	R277,278,280,305,311	R304,305,311	R309	R402	C206,226,230,231	C227,232,247,248	C228,229,249,250,273,274,277,280,282,283,302	C271,272	C281	C304,305	C306,307	K2	TH1			
U.S.A.	K																																						
EUROPE	E2		3-82	YES	YES	(8P)	NO	NO	NO	YES	NO	STK411-230K or STK411-230D	STK410-030K or STK410-030D	YES	2SB1640	NO	NO	NO	NO	430	33K	YES				300	22K	27K	51K	10K/10W	40K	3900P50	10u100	YES	NO	4700u63	3300u35	YES	NO

**KRF-V6010W (X09-4903-82)**

DESTINATION	COUNTRY	ABB	UNIT No.	CN10	J8,9	J10	J11,12	WH2,3	W26,31,44,56,70,83,107,120,224,302,313,352-355	W59,61,79,90,227,228,230,238,239,301,351	IC3	IC4	Q21,40,41	Q31	Q42	D10-13,20,31,50,51,54	D52,59	R205,206,223,230,236,237,238,239,240,208,209	R207,208	R213,236	R216,220,239,240,281-283,306,307,312,450-454	R225,226,233	R245,246,253,2
-------------	---------	-----	----------	------	------	-----	--------	-------	--	--	-----	-----	-----------	-----	-----	-----------------------	--------	--	----------	----------	--	--------------	----------------

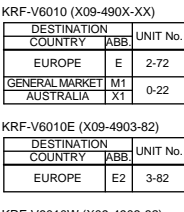
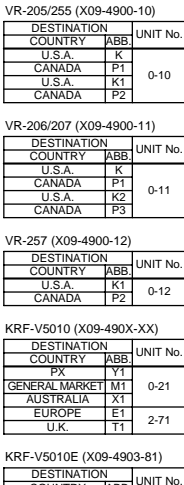
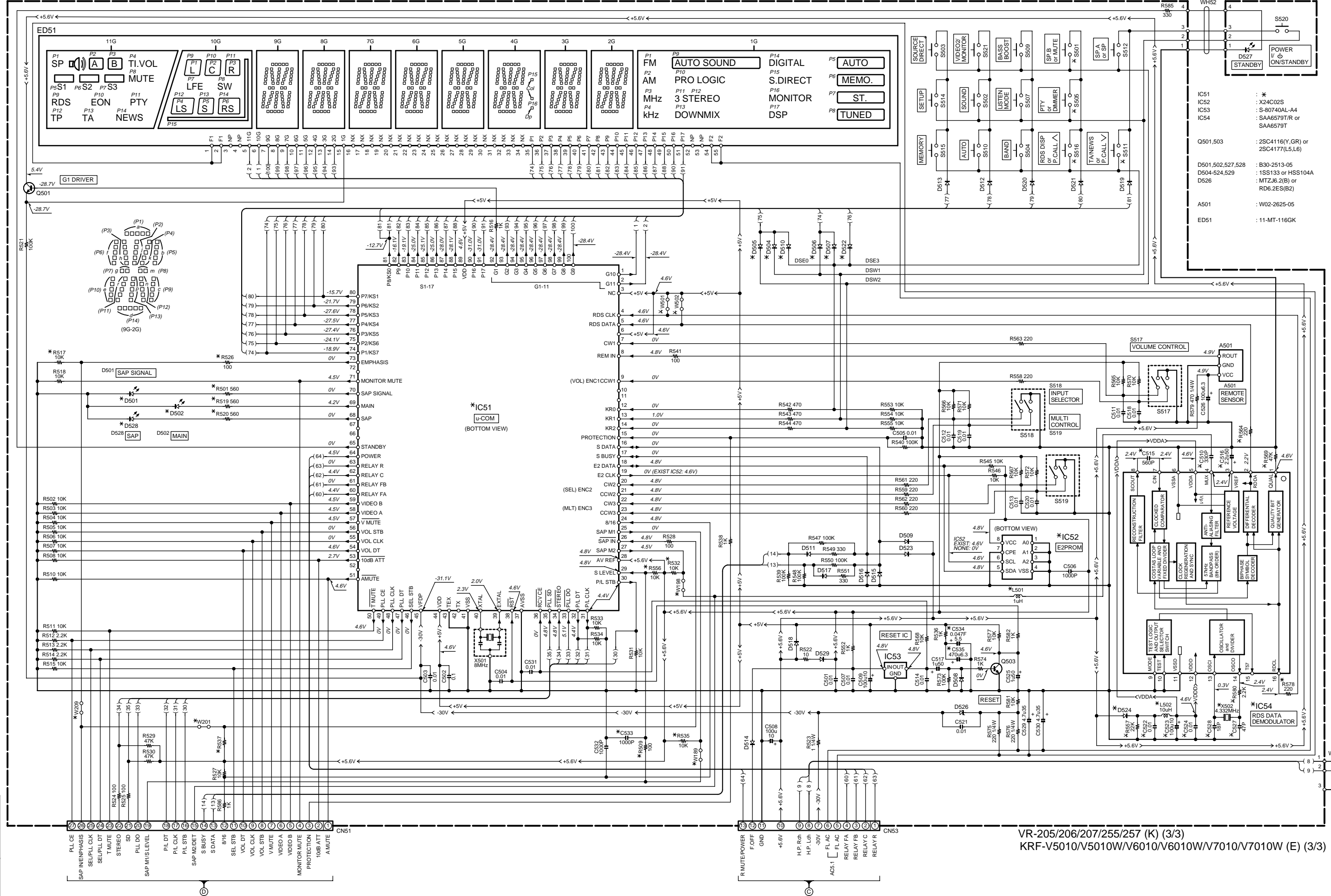

DESTINATION	COUNTRY	UNIT No.	IC51	IC52,54	D501,502,504-507,510,524,528	D504,505,507,510,524,528	W198,201,209	W501,502	R501,509,517,519,520,526,557,564,569,578,580	R509,532,535,557,564,569,578,580	R517,526,556	R532,535,556	R537	C510,515,516,522-524,527,528,533,534	C535	L501,502	X502	S501	S505	S511	S516
-------------	---------	----------	------	---------	------------------------------	--------------------------	--------------	----------	--	----------------------------------	--------------	--------------	------	--------------------------------------	------	----------	------	------	------	------	------

DESTINATION	COUNTRY	UNIT No.	IC51	IC52,54	D501,502,504-507,510,524,528	D504,505,507,510,524,528	W198,201,209	W501,502	R501,509,517,519,520,526,557,564,569,578,580	R509,532,535,557,564,569,578,580	R517,526,556	R532,535,556	R537	C510,515,516,522-524,527,528,533,534	C535	L501,502	X502	S501	S505	S511	S516
-------------	---------	----------	------	---------	------------------------------	--------------------------	--------------	----------	--	----------------------------------	--------------	--------------	------	--------------------------------------	------	----------	------	------	------	------	------

DESTINATION	COUNTRY	UNIT No.	IC51	IC52,54	D501,502,504-507,510,524,528	D504,505,507,510,524,528	W198,201,209	W209	R501,519,520,556	R509,532,535,557,564,569,578,580	R517,526,556	R532,535,556	R537	C510,515,516,522-524,527,528,533,534	C535	L501,502	X502	S501	S505	S511	S516
-------------	---------	----------	------	---------	------------------------------	--------------------------	--------------	------	------------------	----------------------------------	--------------	--------------	------	--------------------------------------	------	----------	------	------	------	------	------

DESTINATION	COUNTRY	UNIT No.	IC51	IC52,54	D501,502,504-507,510,524,528	D504,505,507,510,524,528	W198,201,209	W501,502	R501,519,520,556	R509,532,535,557,564,569,578,580	R517,526,556	R532,535,556	R537	C510,515,516,522-524,527,528,533,534	C535	L501,502	X502	S501	S505	S511	S516
-------------	---------	----------	------	---------	------------------------------	--------------------------	--------------	----------	------------------	----------------------------------	--------------	--------------	------	--------------------------------------	------	----------	------	------	------	------	------

DESTINATION	COUNTRY	UNIT No.	IC51	IC52,54	D501,502,504-507,510,524,528	D504,505,507,510,524,528	W198,201,209	W501,502	R501,519,520,556	R509,532,535,557,564,569,578,580	R517,526,556	R532,535,556	R537	C510,515,516,522-524,527,528,533,534	C535	L501,502	X502	S501	S505	S511	S516
-------------	---------	----------	------	---------	------------------------------	--------------------------	--------------	----------	------------------	----------------------------------	--------------	--------------	------	--------------------------------------	------	----------	------	------	------	------	------

DESTINATION	COUNTRY	UNIT No.	IC51	IC52,54	D501,502,504-507,510,524,528	D504,505,507,510,524,528	W198,201,209	W501,502	R501,519,520,556	R509,532,535,557,564,569,578,580	R517,526,556	R532,535,556	R537	C510,515,516,522-524,527,528,533,534	C535	L501,502	X502	S501	S505	S511	S516
-------------	---------	----------	------	---------	------------------------------	--------------------------	--------------	----------	------------------	----------------------------------	--------------	--------------	------	--------------------------------------	------	----------	------	------	------	------	------

DESTINATION	COUNTRY	UNIT No.	IC51	IC52,54	D501,502,504-507,510,524,528	D504,505,507,510,524,528	W198,201,209	W501,502	R501,519,520,556	R509,532,535,557,564,569,578,580	R517,526,556	R532,535,556	R537	C510,515,516,522-524,527,528,533,534	C535	L501,502	X502	S501	S505	S511	S516
-------------	---------	----------	------	---------	------------------------------	--------------------------	--------------	----------	------------------	----------------------------------	--------------	--------------	------	--------------------------------------	------	----------	------	------	------	------	------

DESTINATION	COUNTRY	UNIT No.	IC51	IC52,54	D501,502,504-507,510,524,528	D504,505,507,510,524,528	W198,201,209	W501,502	R501,519,520,556	R509,532,535,557,564,569,578,580	R517,526,556	R532,535,556	R537	C510,515,516,522-524,527,528,533,534	C535	L501,502	X502	S501	S505	S511	S516
-------------	---------	----------	------	---------	------------------------------	--------------------------	--------------	----------	------------------	----------------------------------	--------------	--------------	------	--------------------------------------	------	----------	------	------	------	------	------

DESTINATION	COUNTRY	UNIT No.	IC51	IC52,54	D501,502,504-507,510,524,528	D504,505,507,510,524,528	W198,201,209	W501,502	R501,519,520,556	R509,532,535,557,564,569,578,580	R517,526,556	R532,535,556	R537	C510,515,516,522-524,527,528,533,534	C535	L501,502	X502	S501	S505	S511	S516
-------------	---------	----------	------	---------	------------------------------	--------------------------	--------------	----------	------------------	----------------------------------	--------------	--------------	------	--------------------------------------	------	----------	------	------	------	------	------

DESTINATION	COUNTRY	UNIT No.	IC51	IC52,54	D501,502,504-507,510,524,528	D504,505,507,510,524,528	W198,201,209	W501,502	R501,519,520,556	R509,532,535,557,564,569,578,580	R517,526,556	R532,535,556	R537	C510,515,516,522-524,527,528,533,534	C535	L501,502	X502	S501	S505	S511	S516
-------------	---------	----------	------	---------	------------------------------	--------------------------	--------------	----------	------------------	----------------------------------	--------------	--------------	------	--------------------------------------	------	----------	------	------	------	------	------

DESTINATION	COUNTRY	UNIT No.	IC51	IC52,54	D501,502,504-507,510,524,528	D504,505,507,510,524,528	W198,201,209	W501,502	R501,519,520,556	R509,532,535,557,564,569,578,580	R517,526,556	R532,535,556	R537	C510,515,516,522-524,527,528,533,534	C535	L501,502	X502	S501	S505	S511	S516
-------------	---------	----------	------	---------	------------------------------	--------------------------	--------------	----------	------------------	----------------------------------	--------------	--------------	------	--------------------------------------	------	----------	------	------	------	------	------

DESTINATION	COUNTRY	UNIT No.	IC51	IC52,54	D501,502,504-507,510,524,528	D504,505,507,510,524,528	W198,201,209	W501,502	R501,519,520,556	R509,532,535,557,564,569,578,580	R517,526,556	R532,535,556	R537	C510,515,516,522-524,527,528,533,534	C535	L501,502	X502	S501	S505	S511	S516
-------------	---------	----------	------	---------	------------------------------	--------------------------	--------------	----------	------------------	----------------------------------	--------------	--------------	------	--------------------------------------	------	----------	------	------	------	------	------

**CAUTION:** For continued safety, replace safety critical components only with manufacturer's recommended parts (refer to parts list). A. indicates safety critical components. For continued protection against risk of fire, replace only with same type and rating fuse(s). To reduce the risk of electric shock, leakage-current or resistance measurements shall be carried out (exposed parts are acceptably insulated from the supply circuit) before the appliance is returned to the customer.

The DC voltage is an actual reading measured with a high impedance type voltmeter with no signal input. The measurement value may vary depending on the measuring instruments used or on the product.



VR-205/206/207/255/257 (K) (3/3)  
KRF-V5010/V5010W/V6010/V6010W/V7010/V7010W (E) (3/3)

Parts with exploded numbers larger than 700 are not supplied.

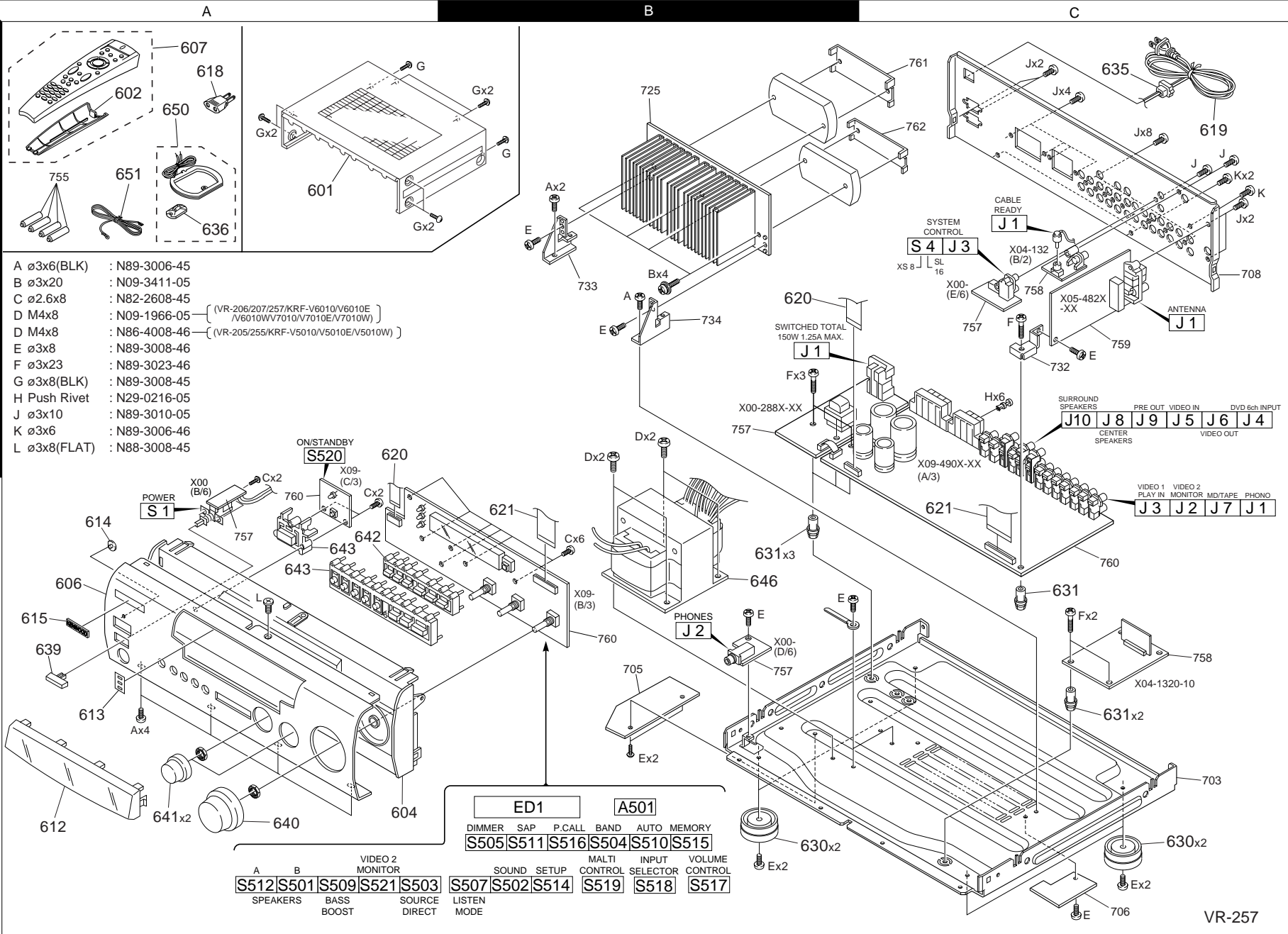

- A  $\phi$ 3x6(BLK) : N89-3006-45
- B  $\phi$ 3x20 : N09-3411-05
- C  $\phi$ 2.6x8 : N82-2608-45
- D M4x8 : N09-1966-05 (VR-206/207/257/KRF-V6010/V6010E /V6010WV7010/V7010E/V7010W)
- D M4x8 : N86-4008-46 (VR-205/255/KRF-V5010/V5010E/V5010W)
- E  $\phi$ 3x8 : N89-3008-46
- F  $\phi$ 3x23 : N89-3023-46
- G  $\phi$ 3x8(BLK) : N89-3008-45
- H Push Rivet : N29-0216-05
- J  $\phi$ 3x10 : N89-3010-05
- K  $\phi$ 3x6 : N89-3006-46
- L  $\phi$ 3x8(FLAT) : N88-3008-45

ED1		A501	
DIMMER	SAP	P.CALL	BAND
AUTO	MEMORY		
S505	S511	S516	S504
S510	S515		
VIDEO 2 MONITOR		SOUND SETUP	
A	B		
S512	S501	S509	S521
S503	S507		S502
S514	S519		S518
S517	S513		S512
SPEAKERS		LISTEN MODE	
BASS BOOST			
SOURCE DIRECT			
		MULTI CONTROL	
		INPUT SELECTOR	
		VOLUME CONTROL	

\* New Parts  
 Parts without **Parts No.** are not supplied.  
 Les articles non mentionnés dans le **Parts No.** ne sont pas fournis.  
 Teile ohne **Parts No.** werden nicht geliefert.



Ref. No	Add-ress	New Parts	Parts No.	Description	Desti-nation	Re-marks
<b>VR-206/207/257/KRF-V7010/V7010E/V7010W</b>						
601	1A	*	A01-3534-01	METALLIC CABINET	KP1Y1	
601	1A	*	A01-3534-01	METALLIC CABINET	M1X1K1	
601	1A	*	A01-3534-01	METALLIC CABINET	P2K2P3	
601	1A	*	A01-3545-01	METALLIC CABINET	E1T1Q1	
601	1A	*	A01-3545-01	METALLIC CABINET	E2	
602	1A		A09-0366-08	BATTERY COVER	KP1Y1	
602	1A		A09-0366-08	BATTERY COVER	M1X1E1	
602	1A		A09-0366-08	BATTERY COVER	P2E2	
602	1A		A09-0366-08	BATTERY COVER	T1Q1K1	
602	1A	*	A09-0396-08	BATTERY COVER	K2P3	
604	2A	*	A22-1804-11	SUB PANEL	E1T1Q1	
604	2A	*	A22-1804-11	SUB PANEL	E2	
606	2A	*	A60-1319-12	PANEL	E1T1Q1	
606	2A	*	A60-1319-12	PANEL	E2	
606	2A	*	A60-1320-11	PANEL	KP1	
606	2A	*	A60-1321-11	PANEL	Y1	
606	2A	*	A60-1368-11	PANEL	K1P2	
606	2A	*	A60-1375-11	PANEL	K2P3	
606	2A	*	A60-1443-01	PANEL	M1X1	
607	1A		A70-1194-05	REMOTE CONTROL ASSY(RC-R0607)	KP1Y1	
607	1A		A70-1194-05	REMOTE CONTROL ASSY(RC-R0607)	M1K1P2	
607	1A	*	A70-1195-05	REMOTE CONTROL ASSY(RC-R0507)	Q1E2	
607	1A	*	A70-1195-05	REMOTE CONTROL ASSY(RC-R0507)	X1E1T1	
607	1A	*	A70-1199-05	REMOTE CONTROL ASSY(RC-R0407)	K2P3	
612	2A	*	B10-2439-02	FRONT GLASS	KP1Y1	
612	2A	*	B10-2439-02	FRONT GLASS	M1X1E1	
612	2A	*	B10-2439-02	FRONT GLASS	P3E2	
612	2A	*	B10-2439-02	FRONT GLASS	T1Q1K2	
612	2A	*	B10-2440-02	FRONT GLASS	K1P2	
613	2A		B11-0361-04	SMOKED FILTER	K1P2	
613	2A	*	B11-0362-04	SMOKED FILTER	K1P2	
614	2A	*	B12-0334-14	INDICATOR	X1	
615	2A		B43-0302-04	KENWOOD BADGE		
-	-		B46-0096-53	WARRANTY CARD	X1	
-	-		B46-0197-00	QUESTIONNAIRE CARD	KK1K2	
-	-		B46-0310-03	WARRANTY CARD	E1T1Q1	
-	-		B46-0310-03	WARRANTY CARD	E2	
-	-		B46-0330-03	WARRANTY CARD	KY1K1	
-	-		B46-0330-03	WARRANTY CARD	K2	
-	-		B46-0336-03	WARRANTY CARD	P1P2P3	
-	-		B58-0513-04	CAUTION CARD (PRESET220-240)	Y1	
-	-		B58-0945-03	CAUTION CARD	T1	
-	-		B58-0964-13	CAUTION CARD (UL)	KY1K1	
-	-		B58-0964-13	CAUTION CARD (UL)	K2	
-	-	*	B58-0965-13	CAUTION CARD (T,XtypePL)	X1T1	
-	-	*	B58-0966-13	CAUTION CARD (ELMtypePL)	M1E1	
-	-	*	B58-0967-03	CAUTION CARD (PtypePL)	P1P2P3	
-	-	*	B58-1607-03	CAUTION CARD	Q1E2	
-	-		B59-1104-00	SERVICE DIRECTORY	Y1	
-	-	*	B59-1404-03	CATALOG	KP1K2	
-	-	*	B59-1404-03	CATALOG	P3	
-	-	*	B59-1406-00	CATALOG	KP1K2	
-	-	*	B59-1406-00	CATALOG	P3	

L : Scandinavia    K : USA    P : Canada    R : Mexico    C : China    I : Malaysia  
 Y : PX(Far East, Hawaii)    T : Europe    E : Europe    G : Germany    V : China (Shanghai)  
 Y : AAFES(Europe)    X : Australia    Q : Russia    H : Korea    M : Other Areas    Δ indicates safety critical components.



\* New Parts  
 Parts without **Parts No.** are not supplied.  
 Les articles non mentionnés dans le **Parts No.** ne sont pas fournis.  
 Teile ohne **Parts No.** werden nicht geliefert.

Ref. No	Add-ress	New Parts	Parts No.	Description	Desti-nation	Re-marks
-	-	*	B59-1407-00	CATALOG	P1P3	
-	-	*	B60-3605-00	INSTRUCTION MANUAL(I/SP)	E1	
-	-	*	B60-3606-00	INSTRUCTION MANUAL(HG/CZ)	E2	
-	-	*	B60-3609-00	INSTRUCTION MANUAL(ENGLISH)	T1Q1E2	
-	-	*	B60-3610-00	INSTRUCTION MANUAL(ENGLISH)	KP1Y1	
-	-	*	B60-3610-00	INSTRUCTION MANUAL(ENGLISH)	M1X1K1	
-	-	*	B60-3610-00	INSTRUCTION MANUAL(ENGLISH)	P2K2P3	
-	-	*	B60-3610-00	INSTRUCTION MANUAL(F/D)	E1	
-	-	*	B60-3612-00	INSTRUCTION MANUAL(FRENCH)	P1P2P3	
-	-	*	B60-3613-00	INSTRUCTION MANUAL(GERMAN)	E1	
-	-	*	B60-3614-00	INSTRUCTION MANUAL(SP/CHINESE)	M1	
-	-	*	B60-3616-00	INSTRUCTION MANUAL(PH)	E2	
-	-	*	B60-3617-00	INSTRUCTION MANUAL(ENGLISH)	E2	
-	-	*	B60-3617-00	INSTRUCTION MANUAL(ENGLISH)	X1T1Q1	
-	-	*	B60-3618-00	INSTRUCTION MANUAL(ENGLISH)	KP1Y1	
-	-	*	B60-3618-00	INSTRUCTION MANUAL(ENGLISH)	M1K1P2	
-	-	*	B60-3619-00	INSTRUCTION MANUAL(F/D/I/SP)	E1	
-	-	*	B60-3620-00	INSTRUCTION MANUAL(FRENCH)	P1P2	
-	-	*	B60-3621-00	INSTRUCTION MANUAL(SP/CHINESE)	M1	
-	-	*	B60-3623-00	INSTRUCTION MANUAL(PH/HG/CZ/R)	Q1E2	
-	-	*	B60-3625-00	INSTRUCTION MANUAL(E/F)	K1P2	
-	-	*	B60-3626-00	INSTRUCTION MANUAL(R)	Q1	
Δ	618	1A	E03-0115-05	AC PLUG ADAPTER	M1	
Δ	619	1C	E30-2605-05	AC POWER CORD	Y1	
Δ	619	1C	E30-2717-05	AC POWER CORD	X1	
Δ	619	1C	E30-2721-05	AC POWER CORD	T1	
Δ	619	1C	E30-2842-05	AC POWER CORD	E2	
Δ	619	1C	E30-2842-05	AC POWER CORD	M1E1Q1	
Δ	619	1C	E30-2849-05	AC POWER CORD	KP1K1	
Δ	619	1C	E30-2849-05	AC POWER CORD	P2K2P3	
Δ	620	1A,1B	E35-2017-05	FLAT CABLE(13P)		
Δ	621	2B,2C	E35-2042-05	FLAT CABLE(27P)		
Δ	F1		F50-0077-05	FUSE(5X20)	125V	8A
Δ	F1		F50-0077-05	FUSE(5X20)	125V	8A
Δ	F1		F50-0101-05	FUSE(5X20)	250V	T3.15AL
Δ	F1		F50-0101-05	FUSE(5X20)	250V	T3.15AL
Δ	F1		F50-0101-05	FUSE(5X20)	250V	T3.15AL
Δ	F3		F50-0100-05	FUSE(5X20)	250V	T2.5AL
-	-		H10-7418-12	POLYSTYRENE FOAMED FIXTURE(L)		
-	-		H10-7419-02	POLYSTYRENE FOAMED FIXTURE(R)		
-	-		H25-0232-04	PROTECTION BAG (235X350X0.03)		
-	-		H25-0232-04	PROTECTION BAG (235X350X0.03)		
-	-		H25-0232-04	PROTECTION BAG (235X350X0.03)		
-	-		H25-0232-04	PROTECTION BAG (235X350X0.03)		
-	-		H25-0232-04	PROTECTION BAG (235X350X0.03)		
-	-		H25-0232-04	PROTECTION BAG (235X350X0.03)		
-	-		H25-0391-04	PROTECTION BAG		
-	-		H25-0651-04	PROTECTION BAG (0232 PRINT)		
-	-	*	H50-2721-04	ITEM CARTON CASE	T1	
-	-	*	H50-2722-04	ITEM CARTON CASE	KP1	
-	-		H50-2723-04	ITEM CARTON CASE	M1	
-	-	*	H50-2723-04	ITEM CARTON CASE	T1	
-	-	*	H50-2723-04	ITEM CARTON CASE	Y1X1E1	
-	-	*	H50-2724-14	ITEM CARTON CASE	Q1	
-	-	*	H50-2725-04	ITEM CARTON CASE	K1P2	
-	-	*	H50-2844-04	ITEM CARTON CASE	K2P3	

L : Scandinavia    K : USA    P : Canada    R : Mexico    C : China    I : Malaysia  
 Y : PX(Far East, Hawaii)    T : Europe    E : Europe    G : Germany    V : China (Shanghai)  
 Y : AAFES(Europe)    X : Australia    Q : Russia    H : Korea    M : Other Areas    Δ indicates safety critical components.

\* New Parts

Parts without **Parts No.** are not supplied.  
Les articles non mentionnés dans le **Parts No.** ne sont pas fournis.  
Teile ohne **Parts No.** werden nicht geliefert.

③

Ref. No	Add-ress	New Parts	Parts No.	Description	Desti-nation	Re-marks
-		*	H50-3085-04	ITEM CARTON CASE	E2	
630	2B,2C		J02-1167-03	FOOT	M1X1E1	
630	2B,2C		J02-1167-03	FOOT	T1Q1E2	
630	2B,2C		J02-1405-03	FOOT (D=46,H=14.5,T)	KP1Y1	
630	2B,2C		J02-1405-03	FOOT (D=46,H=14.5,T)	K1P2K2	
630	2B,2C		J02-1405-03	FOOT (D=46,H=14.5,T)	P3	
635	2B,2C		J19-5787-04	UNIT HOLDER		
636	1C		J42-0083-05	POWER CORD BUSHING		
-	1A		J19-3645-05	ANTENNA STAND		
-			J61-0307-05	WIRE BAND		
639	2A		K27-2185-04	KNOB (POWER)	M1X1E1	
639	2A		K27-2185-04	KNOB (POWER)	T1Q1E2	
639	2A	*	K27-2274-04	KNOB (POWER)	Y1	
640	2A	*	K29-6880-04	KNOB (VOLUME CONTROL)	KP1Y1	
640	2A	*	K29-6880-04	KNOB (VOLUME CONTROL)	K1P2K2	
640	2A		K29-6880-04	KNOB (VOLUME CONTROL)	P3	
640	2A	*	K29-7306-14	KNOB (VOLUME CONTROL)	M1X1E1	
640	2A	*	K29-7306-14	KNOB (VOLUME CONTROL)	T1Q1E2	
641	2A		K29-6881-04	KNOB (MULTI CONTROL)	KP1Y1	
641	2A		K29-6881-04	KNOB (MULTI CONTROL)	K1P2K2	
641	2A		K29-6881-04	KNOB (MULTI CONTROL)	P3	
641	2A	*	K29-7307-14	KNOB (MULTI CONTROL)	M1X1E1	
641	2A	*	K29-7307-14	KNOB (MULTI CONTROL)	T1Q1E2	
642	2A		K29-6898-03	KNOB	KP1Y1	
642	2A		K29-6898-03	KNOB	K2P3	
642	2A	*	K29-6899-13	KNOB	E1T1Q1	
642	2A	*	K29-6899-13	KNOB	E2	
642	2A	*	K29-6907-03	KNOB	K1P2	
642	2A	*	K29-7366-03	KNOB	M1X1	
643	2A	*	K29-6939-12	KNOB	KP1Y1	
643	2A	*	K29-6939-12	KNOB	K1P2K2	
643	2A	*	K29-6939-12	KNOB	P3	
643	2A	*	K29-7365-12	KNOB	M1X1	
646	2A	*	L07-2479-05	POWER TRANSFORMER	KP1K1	
646	2A	*	L07-2479-05	POWER TRANSFORMER	P2K2P3	
646	2A	*	L07-2480-05	POWER TRANSFORMER	E1T1	
646	2A	*	L07-2481-05	POWER TRANSFORMER	Y1M1	
646	2A	*	L07-2482-05	POWER TRANSFORMER	Q1E2	
646	2A	*	L07-2483-05	POWER TRANSFORMER	X1	
650	1A		T90-0833-05	LOOP ANTENNA		
651	1A		T90-0836-05	LEAD WIRE ANTENNA		
<b>VR-205/255/KRF-V5010/V5010E/V5010W</b>						
601	1A		A01-3534-01	METALLIC CABINET		
602	1A		A09-0366-08	BATTERY COVER	K1P2	
602	1A	*	A09-0396-08	BATTERY COVER	KP1Y1	
602	1A	*	A09-0396-08	BATTERY COVER	M1X1E1	
602	1A	*	A09-0396-08	BATTERY COVER	T1Q1E2	
606	2A	*	A60-1323-21	PANEL	KP1	
606	2A	*	A60-1324-21	PANEL	Y1	
606	2A	*	A60-1359-21	PANEL	E1T1Q1	
606	2A	*	A60-1359-21	PANEL	E2	
606	2A	*	A60-1376-21	PANEL	K1P2	

L : Scandinavia K : USA P : Canada R : Mexico C : China I : Malaysia  
Y : PX(Far East, Hawaii) T : Europe E : Europe G : Germany V : China (Shanghai)  
Y : AAFES(Europe) X : Australia Q : Russia H : Korea M : Other Areas Δ indicates safety critical components.

\* New Parts

Parts without **Parts No.** are not supplied.  
Les articles non mentionnés dans le **Parts No.** ne sont pas fournis.  
Teile ohne **Parts No.** werden nicht geliefert.

④

Ref. No	Add-ress	New Parts	Parts No.	Description	Desti-nation	Re-marks
606	2A	*	A60-1444-01	PANEL	M1X1	
607	1A		A70-1194-05	REMOTE CONTROL ASSY(RC-R0607)	K1P2	
607	1A	*	A70-1196-05	REMOTE CONTROL ASSY(RC-R0307)	E1T1Q1	
607	1A	*	A70-1196-05	REMOTE CONTROL ASSY(RC-R0307)	E2	
607	1A	*	A70-1199-05	REMOTE CONTROL ASSY(RC-R0407)	KP1Y1	
607	1A	*	A70-1199-05	REMOTE CONTROL ASSY(RC-R0407)	M1X1	
612	2A	*	B10-2439-02	FRONT GLASS		
614	2A		B12-0334-14	INDICATOR		
615	2A		B43-0302-04	KENWOOD BADGE		
-			B46-0096-53	WARRANTY CARD	X1	
-			B46-0197-00	QUESTIONNAIRE CARD	KK1	
-			B46-0310-03	WARRANTY CARD	E1T1Q1	
-			B46-0310-03	WARRANTY CARD	E2	
-			B46-0330-03	WARRANTY CARD	KY1K1	
-			B46-0336-03	WARRANTY CARD	P1P2	
-			B58-0513-04	CAUTION CARD (PRESET220-240)	Y1	
-			B58-0945-03	CAUTION CARD	T1	
-			B58-0964-13	CAUTION CARD (UL)	KY1K1	
-		*	B58-0965-13	CAUTION CARD (T,XtypePL)	X1T1	
-		*	B58-0966-13	CAUTION CARD (ELMtypePL)	M1E1	
-		*	B58-0967-03	CAUTION CARD (PtypePL)	P1P2	
-		*	B58-1607-03	CAUTION CARD	Q1E2	
-			B59-1104-00	SERVICE DIRECTORY	Y1	
-		*	B59-1404-03	CATALOG	KP1K1	
-		*	B59-1404-03	CATALOG	P2	
-		*	B59-1406-00	CATALOG	KP1K1	
-		*	B59-1406-00	CATALOG	P2	
-		*	B59-1407-00	CATALOG	P1P2	
-		*	B60-3605-00	INSTRUCTION MANUAL(I/SP)	E1	
-		*	B60-3606-00	INSTRUCTION MANUAL(HG/CZ)	E2	
-		*	B60-3609-00	INSTRUCTION MANUAL(ENGLISH)	T1Q1E2	
-		*	B60-3610-00	INSTRUCTION MANUAL(ENGLISH)	KP1Y1	
-		*	B60-3610-00	INSTRUCTION MANUAL(ENGLISH)	M1X1K1	
-		*	B60-3610-00	INSTRUCTION MANUAL(ENGLISH)	P2	
-		*	B60-3611-00	INSTRUCTION MANUAL(F/D)	E1	
-		*	B60-3612-00	INSTRUCTION MANUAL(FRENCH)	P1P2	
-		*	B60-3613-00	INSTRUCTION MANUAL(GERMAN)	E1	
-		*	B60-3614-00	INSTRUCTION MANUAL(SP/CHINESE)	M1	
-		*	B60-3616-00	INSTRUCTION MANUAL(PH)	E2	
-		*	B60-3618-00	INSTRUCTION MANUAL(ENGLISH)	K1P2	
-		*	B60-3620-00	INSTRUCTION MANUAL(FRENCH)	P2	
Δ 618	1A		E03-0115-05	AC PLUG ADAPTER	M1	
Δ 619	1C		E30-2605-05	AC POWER CORD	Y1	
Δ 619	1C		E30-2717-05	AC POWER CORD	X1	
Δ 619	1C		E30-2721-05	AC POWER CORD	T1	
Δ 619	1C		E30-2842-05	AC POWER CORD	E2	
Δ 619	1C		E30-2842-05	AC POWER CORD	M1E1Q1	
Δ 619	1C		E30-2849-05	AC POWER CORD	KP1K1	
Δ 619	1C		E30-2849-05	AC POWER CORD	P2	
620	1A,1B		E35-2017-05	FLAT CABLE		
621	2B,2C	*	E35-2042-05	FLAT CABLE		
Δ F1			F50-0076-05	FUSE(5X20) 125V 6.3A	KP1K1	
Δ F1			F50-0076-05	FUSE(5X20) 125V 6.3A	P2	
Δ F2		*	F50-0099-05	FUSE(5X20) 250V T2AL	E1T1Q1	

L : Scandinavia K : USA P : Canada R : Mexico C : China I : Malaysia  
Y : PX(Far East, Hawaii) T : Europe E : Europe G : Germany V : China (Shanghai)  
Y : AAFES(Europe) X : Australia Q : Russia H : Korea M : Other Areas Δ indicates safety critical components.



\* New Parts  
Parts without **Parts No.** are not supplied.  
Les articles non mentionnes dans le **Parts No.** ne sont pas fournis.  
Teile ohne **Parts No.** werden nicht geliefert.

5

Ref. No	Add-ress	New Parts	Parts No.	Description	Desti-nation	Re-marks
Δ F2		*	F50-0099-05	FUSE(5X20) 250V T2AL	E2	
Δ F2		*	F50-0099-05	FUSE(5X20) 250V T2AL	Y1M1X1	
Δ F3			F50-0100-05	FUSE(5X20) 250V T2.5AL	E1Q1E2	
-			H10-7418-12	POLYSTYRENE FOAMED FIXTURE(L)		
-			H10-7419-02	POLYSTYRENE FOAMED FIXTURE(R)		
-			H25-0232-04	PROTECTION BAG (235X350X0.03)	E2	
-			H25-0232-04	PROTECTION BAG (235X350X0.03)	KP1Y1	
-			H25-0232-04	PROTECTION BAG (235X350X0.03)	M1X1E1	
-			H25-0232-04	PROTECTION BAG (235X350X0.03)	Q1K1P2	
-			H25-0232-04	PROTECTION BAG (235X350X0.03)		
-			H25-0391-04	PROTECTION BAG		
-			H25-0651-04	PROTECTION BAG (0232 PRI)	T1	
-		*	H50-2727-04	ITEM CARTON CASE	KP1	
-		*	H50-2728-04	ITEM CARTON CASE	M1	
-		*	H50-2729-04	ITEM CARTON CASE	T1	
-		*	H50-2729-04	ITEM CARTON CASE	Y1X1E1	
-		*	H50-2730-14	ITEM CARTON CASE	Q1	
-		*	H50-2731-04	ITEM CARTON CASE	K1P2	
-		*	H50-3086-04	ITEM CARTON CASE	E2	
630	2B,2C		J02-1167-03	FOOT	M1X1E1	
630	2B,2C		J02-1167-03	FOOT	T1Q1E2	
630	2B,2C		J02-1405-03	FOOT (D=46,H=14.5,T)	KP1Y1	
630	2B,2C		J02-1405-03	FOOT (D=46,H=14.5,T)	K1P2	
631	2B,2C		J19-5787-04	UNIT HOLDER		
Δ 635	1C		J42-0083-05	POWER CORD BUSHING		
636	1A		J19-3645-05	ANTENNA STAND	E1T1Q1	
-			J61-0307-05	WIRE BAND	E2	
-			J61-0307-05	WIRE BAND	Y1M1X1	
-			J61-0307-05	WIRE BAND		
639	2A		K27-2185-04	KNOB (POWER)	M1X1E1	
639	2A		K27-2185-04	KNOB (POWER)	T1Q1E2	
639	2A	*	K27-2274-04	KNOB (POWER)	Y1	
640	2A		K29-6880-04	KNOB (VOLUME CONTROL)	KP1Y1	
640	2A		K29-6880-04	KNOB (VOLUME CONTROL)	K1P2	
640	2A	*	K29-7306-14	KNOB (VOLUME CONTROL)	M1X1E1	
640	2A	*	K29-7306-14	KNOB (VOLUME CONTROL)	T1Q1E2	
641	2A		K29-6881-04	KNOB (MULTI CONTROL)	KP1Y1	
641	2A		K29-6881-04	KNOB (MULTI CONTROL)	K1P2	
641	2A	*	K29-7307-14	KNOB (MULTI CONTROL)	M1X1E1	
641	2A	*	K29-7307-14	KNOB (MULTI CONTROL)	T1Q1E2	
642	2A		K29-6898-03	KNOB	KP1Y1	
642	2A		K29-6898-03	KNOB	K1P2	
642	2A	*	K29-6899-13	KNOB	E1T1Q1	
642	2A	*	K29-6899-13	KNOB	E2	
642	2A	*	K29-7366-03	KNOB	M1X1	
643	2A	*	K29-6939-12	KNOB	KP1Y1	
643	2A	*	K29-6939-12	KNOB	K1P2	
643	2A	*	K29-7365-12	KNOB	M1X1E1	
643	2A	*	K29-7365-12	KNOB	T1Q1E2	
Δ 646	2A	*	L07-2470-15	POWER TRANSFORMER	KP1K1	
Δ 646	2A	*	L07-2470-15	POWER TRANSFORMER	P2	
Δ 646	2A	*	L07-2471-05	POWER TRANSFORMER	E1T1	
Δ 646	2A	*	L07-2472-05	POWER TRANSFORMER	Y1M1	
Δ 646	2A	*	L07-2473-05	POWER TRANSFORMER	Q1E2	
Δ 646	2A	*	L07-2474-05	POWER TRANSFORMER	X1	

L: Scandinavia K: USA P: Canada R: Mexico C: China I: Malaysia  
Y: PX(Far East, Hawaii) T: Europe E: Europe G: Germany V: China (Shanghai)  
Y: AAFES(Europe) X: Australia Q: Russia H: Korea M: Other Areas Δ indicates safety critical components.

\* New Parts  
Parts without **Parts No.** are not supplied.  
Les articles non mentionnes dans le **Parts No.** ne sont pas fournis.  
Teile ohne **Parts No.** werden nicht geliefert.

6

Ref. No	Add-ress	New Parts	Parts No.	Description	Desti-nation	Re-marks
650	1A		T90-0833-05	LOOP ANTENNA		
651	1A		T90-0836-05	LEAD WIRE ANTENNA		
<b>KRF-V6010/V6010E/V6010W</b>						
601	1A	*	A01-3534-01	METALLIC CABINET		
602	1A	*	A09-0396-08	BATTERY COVER		
606	2A	*	A60-1334-11	PANEL		EQ1E1
606	2A	*	A60-1335-11	PANEL		M1X1
607	1A	*	A70-1196-05	REMOTE CONTROL ASSY(RC-R0307)		EQ1E1
607	1A	*	A70-1199-05	REMOTE CONTROL ASSY(RC-R0407)		M1X1
612	2A	*	B10-2439-02	FRONT GLASS		
614	2A	*	B12-0334-14	INDICATOR		
615	2A	*	B43-0302-04	KENWOOD BADGE		
-		*	B46-0096-53	WARRANTY CARD		X1
-		*	B46-0310-03	WARRANTY CARD		E1Q1E2
-		*	B58-0965-13	CAUTION CARD (T_XtyoePL)		X1
-		*	B58-0966-13	CAUTION CARD (ELMtypePL)		E1M1
-		*	B58-1607-03	CAUTION CARD		Q1E2
-		*	B60-3605-00	INSTRUCTION MANUAL(I/SP)		E1
-		*	B60-3606-00	INSTRUCTION MANUAL(HG/CZ)		E2
-		*	B60-3609-00	INSTRUCTION MANUAL(ENGLISH)		Q1E2
-		*	B60-3610-00	INSTRUCTION MANUAL(ENGLISH)		M1X1
-		*	B60-3611-00	INSTRUCTION MANUAL(F/D)		E1
-		*	B60-3614-00	INSTRUCTION MANUAL(SP/CHINESE)		M1
-		*	B60-3616-00	INSTRUCTION MANUAL(PH)		E2
-		*	B60-3626-00	INSTRUCTION MANUAL(R)		Q1
Δ 618	1A		E03-0115-05	AC PLUG ADAPTER		M1
Δ 619	1C		E30-2717-05	AC POWER CORD		X1
Δ 619	1C		E30-2842-05	AC POWER CORD		E1Q1M1
Δ 619	1C		E30-2842-05	AC POWER CORD		E2
620	1A,1B	*	E35-2017-05	FLAT CABLE(13P)		
621	2B,2C	*	E35-2042-05	FLAT CABLE(27P)		
Δ F1			F50-0101-05	FUSE(5X20) 250V T3.15AL		
Δ F3			F50-0100-05	FUSE(5X20) 250V T2.5AL		E1Q1E2
-		*	H10-7418-12	POLYSTYRENE FOAMED FIXTURE		
-		*	H10-7419-02	POLYSTYRENE FOAMED FIXTURE		
-		*	H25-0232-04	PROTECTION BAG (235X350X0.03)		
-		*	H25-0391-04	PROTECTION BAG		
-		*	H50-2750-04	ITEM CARTON CASE		E1X1
-		*	H50-2751-14	ITEM CARTON CASE		Q1
-		*	H50-2752-04	ITEM CARTON CASE		M1
-		*	H50-3087-04	ITEM CARTON CASE		E2
630	2B,2C		J02-1167-03	FOOT		
631	2B,2C		J19-5787-04	UNIT HOLDER		
Δ 635	1C		J42-0083-05	POWER CORD BUSHING		
636	1A		J19-3645-05	ANTENNA STAND		
-			J61-0307-05	WIRE BAND		
639	2A		K27-2185-04	KNOB (POWER)		
640	2A	*	K29-7306-14	KNOB (VOLUME CONTROL)		
641	2A	*	K29-7307-14	KNOB (MULTI CONTROL)		
641	2A	*	K29-7366-03	KNOB		M1X1
642	2A	*	K29-6899-13	KNOB		E1Q1E2

L: Scandinavia K: USA P: Canada R: Mexico C: China I: Malaysia  
Y: PX(Far East, Hawaii) T: Europe E: Europe G: Germany V: China (Shanghai)  
Y: AAFES(Europe) X: Australia Q: Russia H: Korea M: Other Areas Δ indicates safety critical components.

KRF-V5010/V6010/V7010/VR-205/206/207/255/257  
PARTS LIST

\* New Parts  
Parts without **Parts No.** are not supplied.  
Les articles non mentionnés dans le **Parts No.** ne sont pas fournis.  
Teile ohne **Parts No.** werden nicht geliefert.



Ref. No	Address	New Parts	Parts No.	Description	Destination	Remarks
643	2A	*	K29-7365-12	KNOB		
△ 646	2A	*	L07-2480-05	POWER TRANSFORMER	E1	
△ 646	2A	*	L07-2481-05	POWER TRANSFORMER	M1	
△ 646	2A	*	L07-2482-05	POWER TRANSFORMER	Q1E2	
△ 646	2A	*	L07-2483-05	POWER TRANSFORMER	X1	
650	1A		T90-0833-05	LOOP ANTENNA		
651	1A		T90-0836-05	LEAD WIRE ANTENNA		
<b>POWER SUPPLY UNIT (X00-288X-XX)</b>						
C5 ,6			CK45FF1H103Z	CERAMIC 0.010UF Z		
C7			CE04EW1E331M	ELECTRO 330UF 25WV		
C8			CK45FB1H102K	CERAMIC 1000PF K		
C9			CQ92FM1H104J	MYLAR 0.10UF J		
C10			CE04LW1C470M	ELECTRO 47UF 16WV		
C11			CE04LW1V4R7M	ELECTRO 4.7UF 35WV		
C13 ,14			CC45FSL1H101J	CERAMIC 100PF J		
C21 ,22			CC45FSL1H221J	CERAMIC 220PF J		
C23 -25			CK45FF1H472Z	CERAMIC 4700PF Z	E1T1Q1	7
C23 -25			CK45FF1H472Z	CERAMIC 4700PF Z	E2	7
△ CN1			E40-4245-05	PIN ASSY	Y1M1	
△ CN1 -3			E40-4245-05	PIN ASSY	Q1E2	
△ CN1 -3			E40-4245-05	PIN ASSY	X1E1T1	
△ CN1 ,2			E40-4245-05	PIN ASSY	KP1K1	
△ CN1 ,2			E40-4245-05	PIN ASSY	P2K2P3	
CN3			E40-4245-05	PIN ASSY	Y1M1	
CN4			E40-8197-05	SOCKET FOR PIN ASSY		
CN11			E40-4281-05	PIN ASSY	Y1M1	
CN12,13			E40-3247-05	PIN ASSY		
CN14			E40-4101-05	PIN ASSY	E1T1Q1	
△ CN14			E40-4101-05	PIN ASSY	E2	
△ J1			E03-0148-05	AC OUTLET	KP1Y1	
△ J1			E03-0148-05	AC OUTLET	K1P2K2	
△ J1			E03-0148-05	AC OUTLET	P3	
△ J1			E03-0149-05	AC OUTLET	E2	
△ J1			E03-0149-05	AC OUTLET	M1E1Q1	
△ J1			E03-0310-05	AC OUTLET	T1	
△ J1			E03-0325-05	AC OUTLET	X1	
J2			E11-0295-05	PHONE JACK (3P)		
J3			E11-0347-05	MINIATURE PHONE JACK(2P)		
J4			E70-0089-05	SCREW TERMINAL BOARD	E1T1Q1	7
J4			E70-0089-05	SCREW TERMINAL BOARD	E2	7
CN5 ,6			J13-0075-05	FUSE CLIP		
CN7 ,8			J13-0075-05	FUSE CLIP	Y1M1	
CN9 ,10			J13-0075-05	FUSE CLIP	E1Q1E2	
E1			J11-0808-05	WIRE CLAMPER		
△ T1			L07-2127-05	POWER TRANSFORMER	KP1K1	
△ T1			L07-2127-05	POWER TRANSFORMER	P2K2P3	
△ T1			L07-2128-05	POWER TRANSFORMER	Y1M1	
△ T1			L07-2129-05	POWER TRANSFORMER	Q1E2	
△ T1			L07-2129-05	POWER TRANSFORMER	X1E1T1	
△ R1			R92-1844-05	CARBON 3.3M J 1/2W	KP1K1	
△ R1			R92-1844-05	CARBON 3.3M J 1/2W	P2K2P3	
K1			S76-0070-05	MAGNETIC RELAY		

L : Scandinavia K : USA P : Canada R : Mexico C : China I : Malaysia  
Y : PX(Far East, Hawaii) T : Europe E : Europe G : Germany V : China (Shanghai)  
Y : AAFES(Europe) X : Australia Q : Russia H : Korea M : Other Areas △ indicates safety critical components.

\* New Parts  
Parts without **Parts No.** are not supplied.  
Les articles non mentionnés dans le **Parts No.** ne sont pas fournis.  
Teile ohne **Parts No.** werden nicht geliefert.



Ref. No	Address	New Parts	Parts No.	Description	Destination	Remarks
△ S1			S68-0088-05			E1T1Q1
△ S1			S68-0088-05			E2
△ S1			S68-0088-05			Y1M1X1
△ S2 ,3			S62-0001-05	SLIDE SWITCH		Y1M1
△ S4			S62-0034-05	SLIDE SWITCH		
△ D1 -4			S5688B	DIODE		
△ D1 -4			1SR139-400	DIODE		
D5			MTZJ6.2(B)	ZENER DIODE		
D5			RD6.2ES(B2)	ZENER DIODE		
△ D6 ,7			HSS104A	DIODE		
△ D6 ,7			1SS133	DIODE		
△ D8			MTZJ2.7(B)	ZENER DIODE		
△ D8			RD2.7ES(B2)	ZENER DIODE		
△ D9			HSS104A	DIODE		
△ D9			1SS133	DIODE		
△ Q1			2SC3940A(R,S)	TRANSISTOR		
△ Q2			2SC2003(L,K)	TRANSISTOR		
<b>MPX (SAP) UNIT (X04-1320-10) VR-257 ONLY</b>						
C1 ,2			CE04LW1H100M	ELECTRO 10UF 50WV		
C3 ,4			CQ92FM1H102J	MYLAR 1000PF J		
C5			CE04LW1C470M	ELECTRO 47UF 16WV		
C6 ,7			CE04LW1H100M	ELECTRO 10UF 50WV		
C8 ,9			CC45FCH1H101J	CERAMIC 100PF J		
C10 ,11			CQ92FM1H102J	MYLAR 1000PF J		
C14 ,15			CQ92FM1H102J	MYLAR 1000PF J		
C16 ,17			CE04LW1C470M	ELECTRO 47UF 16WV		
C41			CK45FB1H102K	CERAMIC 1000PF K		
C42			CC45FCH1H470J	CERAMIC 47PF J		
C43			CK45FB1H102K	CERAMIC 1000PF K		
CN4			E40-4372-05	PIN ASSY		
CN5			E40-3259-05	PIN ASSY		
J1			E04-0026-05	RF COAXIAL CABLE RECEPTACLE		
J2			E13-0194-05	PHONO JACK (1P)		
L41 ,42		*	L40-1091-82	SMALL FIXED INDUCTOR(1.0UH)		
R27			RD14NB2E391J	RD 390 J 1/4W		
R28			RS14KB3A151J	FL-PROOF RS 150 J 1W		
VR1			R32-0036-05	SEMI FIXED VARIABLE RESISTOR		
D1			HSS104A	DIODE		
D1			1SS133	DIODE		
D2			MTZJ3.3(B)	ZENER DIODE		
D2			RD3.3ES(B2)	ZENER DIODE		
D3 ,4			MTZJ8.2(B)	ZENER DIODE		
D3 ,4			RD8.2ES(B2)	ZENER DIODE		
D5			MTZJ5.1(B)	ZENER DIODE		
D5			RD5.1ES(B2)	ZENER DIODE		
D41 -44			HSS104A	DIODE		
D41 -44			1SS133	DIODE		
IC1 ,2			NJM4565D	ANALOGUE IC		
IC3			BU4052BC	MOS-IC		
Q1			DTA124ESA	DIGITAL TRANSISTOR		
Q1			UN4112	DIGITAL TRANSISTOR		
Q2 ,3			DTC124ESA	DIGITAL TRANSISTOR		

L : Scandinavia K : USA P : Canada R : Mexico C : China I : Malaysia  
Y : PX(Far East, Hawaii) T : Europe E : Europe G : Germany V : China (Shanghai)  
Y : AAFES(Europe) X : Australia Q : Russia H : Korea M : Other Areas △ indicates safety critical components.

\* New Parts  
 Parts without **Parts No.** are not supplied.  
 Les articles non mentionnés dans le **Parts No.** ne sont pas fournis.  
 Teile ohne **Parts No.** werden nicht geliefert.



Ref. No	Add-ress	New Parts	Parts No.	Description	Desti-nation	Re-marks
Q2 ,3			UN4212	DIGITAL TRANSISTOR		
Q4 ,5			2SD1450(S,T)	TRANSISTOR		
Q6 ,7			2SA1048(Y,GR)	TRANSISTOR		
Q6 ,7			2SA1309A(Q,R)	TRANSISTOR		
A1			W02-2635-05	ELECTRIC CIRCUIT MODULE		
<b>TUNER UNIT (X05-482X-XX)</b>						
C1			CK73FB1H223K	CHIP C		
C2			CK73FB1H103K	CHIP C		
C2			CK73FB1H103K	CHIP C		
C3			CK73FB1H103K	CHIP C		
C5 ,6			CK73FB1H103K	CHIP C		
C7			CE04LW1C470M	ELECTRO		
C8			CK73EB1H103K	CHIP C		
C8			CK73EB1H103K	CHIP C		
C8			CK73EB1H103K	CHIP C		
C10			CE04LW1C470M	ELECTRO		
C11 -13			CK73FB1H473K	CHIP C		
C14			CE04LW1C100M	ELECTRO		
C15			CE04LW1H010M	ELECTRO		
C16			C90-3251-05	ELECTRO		
C17			C90-3253-05	ELECTRO		
C18			CC73FCH1H470J	CHIP C		
C19			C90-3217-05	ELECTRO		
C20			CK73FB1H473K	CHIP C		
C21			C90-3241-05	ELECTRO		
C22			CK73FB1H473K	CHIP C		
C23			CE04LW1C100M	ELECTRO		
C24			CK73FB1H331K	CHIP C		
C25			CC73FCH1H181J	CHIP C		
C25			CC73FCH1H181J	CHIP C		
C25			CC73FCH1H391J	CHIP C		
C25			CC73FCH1H391J	CHIP C		
C26			CK73FB1H183K	CHIP C		
C26			CK73FB1H183K	CHIP C		
C26			CK73FB1H223K	CHIP C		
C26			CK73FB1H223K	CHIP C		
C26			CK73FB1H223K	CHIP C		
C27			CE04HW1E4R7M	NP-ELEC		
C28 ,29			C90-3240-05	ELECTRO		
C30 ,31			CK73FB1H223K	CHIP C		
C30 ,31			CK73FB1H223K	CHIP C		
C30 ,31			CK73FB1H333K	CHIP C		
C30 ,31			CK73FB1H333K	CHIP C		
C32			CE04LW1C100M	ELECTRO		
C33 ,34			CK73FB1H103K	CHIP C		
C36			CK73FB1H103K	CHIP C		
C37 ,38			C90-3217-05	ELECTRO		
C39			CC73FCH1H060D	CHIP C		
C40			CC73FCH1H020C	CHIP C		
C41			CC73FCH1H220J	CHIP C		
C42			CC73FCH1H270J	CHIP C		
C43			CC73FCH1H220J	CHIP C		

L : Scandinavia    K : USA    P : Canada    R : Mexico    C : China    I : Malaysia  
 Y : PX(Far East, Hawaii)    T : Europe    E : Europe    G : Germany    V : China (Shanghai)  
 Y : AAFES(Europe)    X : Australia    Q : Russia    H : Korea    M : Other Areas    Δ indicates safety critical components.

\* New Parts  
 Parts without **Parts No.** are not supplied.  
 Les articles non mentionnés dans le **Parts No.** ne sont pas fournis.  
 Teile ohne **Parts No.** werden nicht geliefert.



Ref. No	Add-ress	New Parts	Parts No.	Description	Desti-nation	Re-marks
C44			CK73FB1H471K	CHIP C		
C45			CC73FCH1H220J	CHIP C		
C46			CE04LW1C100M	ELECTRO		
C47			CK73FB1H102K	CHIP C		
C48			CE04LW1C470M	ELECTRO		
C49			CE04LW1H2R2M	ELECTRO		
C50			CC73FSL1H101J	CHIP C		
C51			CK73FB1H471K	CHIP C		
C52			CC73FSL1H101J	CHIP C		
C70 ,71			CK73FB1H822K	CHIP C		
C70 ,71			CK73FB1H822K	CHIP C		
C72			CE04LW1H010M	ELECTRO		
C73			CE04LW1C470M	ELECTRO		
C75			CC73FCH1H040C	CHIP C		
C76			CC73FCH1H470J	CHIP C		
C78			CK73FB1H223K	CHIP C		
C79 ,80			CK73FB1H472K	CHIP C		
C79 ,80			CK73FB1H472K	CHIP C		
C81			CK73FF1C105Z	CHIP C		
C82			CK73FB1H103K	CHIP C		
C82			CK73FB1H103K	CHIP C		
C83			CC73FSL1H101J	CHIP C		
C84 ,85			CK73FB1H223K	CHIP C		
C86			CK73FB1H471K	CHIP C		
CN1			E40-9831-05	SOCKET FOR PIN ASSY		
CN1			E40-9831-05	SOCKET FOR PIN ASSY		
CN1			E40-9831-05	SOCKET FOR PIN ASSY		
CN1			E40-9831-05	SOCKET FOR PIN ASSY		
CN2			E40-4871-05	PIN ASSY		
CN2			E70-0080-05	LOCK TERMINAL BOARD		
CF1 ,2			L72-0531-05	CERAMIC FILTER		
CF1 ,2			L72-0531-05	CERAMIC FILTER		
CF1 ,2		*	L72-0536-05	CERAMIC FILTER		
CF1 ,2		*	L72-0536-05	CERAMIC FILTER		
CF1 ,2			L72-0596-05	CERAMIC FILTER		
CF1 ,2		*	L72-0596-05	CERAMIC FILTER		
CF3		*	L72-0607-05	CERAMIC FILTER		
CF3		*	L72-0607-05	CERAMIC FILTER		
CF3		*	L72-0607-05	CERAMIC FILTER		
L1			L39-1366-05	COMBINATION COIL		
L2			L40-1091-82	SMALL FIXED INDUCTOR(1.0UH)		
L3			L30-0911-05	AM IFT		
L4			L30-0950-05	FM IFT		
L4			L30-0950-05	FM IFT		
L5			L30-0951-05	FM IFT		
L5			L30-0951-05	FM IFT		
L6 ,7			L79-1239-05	LC FILTER		
L6 ,7			L79-1239-05	LC FILTER		
L9		*	L40-1001-82	SMALL FIXED INDUCTOR(10UH)		
X1		*	L77-2187-05	CRYSTAL RESONATOR		
R1			RK73FB2A101J	CHIP R		
R3			RK73FB2A332J	CHIP R		
R3			RK73FB2A332J	CHIP R		

L : Scandinavia    K : USA    P : Canada    R : Mexico    C : China    I : Malaysia  
 Y : PX(Far East, Hawaii)    T : Europe    E : Europe    G : Germany    V : China (Shanghai)  
 Y : AAFES(Europe)    X : Australia    Q : Russia    H : Korea    M : Other Areas    Δ indicates safety critical components.

**KRF-V5010W6010W7010WR-205/206/207/255/257**  
**PARTS LIST**















\* New Parts  
 Parts without **Parts No.** are not supplied.  
 Les articles non mentionnés dans le **Parts No.** ne sont pas fournis.  
 Teile ohne **Parts No.** werden nicht geliefert.

23

Ref. No	Add-ress	New Parts	Parts No.	Description	Desti-nation	Re-marks
R326-330			RK73FB2A102J	CHIP R 1.0K J 1/10W		
R331			RK73FB2A363J	CHIP R 36K J 1/10W		
R332			RK73FB2A751J	CHIP R 750 J 1/10W		
R333			RK73FB2A272J	CHIP R 2.7K J 1/10W		
R361,362			RS14KB3D391J	FL-PROOF RS 390 J 2W		
R363			RK73FB2A473J	CHIP R 47K J 1/10W		
R400			RK73FB2A472J	CHIP R 4.7K J 1/10W		
R403-407			RK73EB2B220J	CHIP R 22 J 1/8W		
R408			RK73FB2A222J	CHIP R 2.2K J 1/10W		
R409			RK73FB2A333J	CHIP R 33K J 1/10W		
R410,411			RK73EB2B224J	CHIP R 220K J 1/8W		
R412,413			RK73FB2A224J	CHIP R 220K J 1/10W		
R414			RK73FB2A103J	CHIP R 10K J 1/10W		
R415			RK73FB2A104J	CHIP R 100K J 1/10W		
R416			RK73FB2A683J	CHIP R 68K J 1/10W		
R417			RK73FB2A473J	CHIP R 47K J 1/10W		
R450,451			RK73FB2A272J	CHIP R 2.7K J 1/10W	7	
R450,451			RK73FB2A272J	CHIP R 2.7K J 1/10W	6	
R452			RK73FB2A361J	CHIP R 360 J 1/10W	7	
R452			RK73FB2A361J	CHIP R 360 J 1/10W	6	
R453			RK73FB2A472J	CHIP R 4.7K J 1/10W	7	
R453			RK73FB2A472J	CHIP R 4.7K J 1/10W	6	
R456			RK73FB2A473J	CHIP R 47K J 1/10W		
R457			RK73FB2A102J	CHIP R 1.0K J 1/10W		
R458			RK73FB2A101J	CHIP R 100 J 1/10W		
R460,461			RK73FB2A102J	CHIP R 1.0K J 1/10W		
R462			RK73EB2B101J	CHIP R 100 J 1/8W		
R514			RK73FB2A222J	CHIP R 2.2K J 1/10W		
R515			RK73FB2A103J	CHIP R 10K J 1/10W		
R523			RD14NB2E1R0J	RD 1 J 1/4W		
R524,525			RK73FB2A101J	CHIP R 100 J 1/10W		
R528			RK73FB2A101J	CHIP R 100 J 1/10W		
R529,530			RK73FB2A473J	CHIP R 47K J 1/10W		
R536			RK73FB2A102J	CHIP R 1.0K J 1/10W		
R545,546			RK73FB2A103J	CHIP R 10K J 1/10W		
R552			RK73FB2A102J	CHIP R 1.0K J 1/10W	KP1Y1 M1X1K1 P2K2P3	
R556			RK73FB2A103J	CHIP R 10K J 1/10W		
R556			RK73FB2A103J	CHIP R 10K J 1/10W		
R556			RK73FB2A103J	CHIP R 10K J 1/10W		
R565			RK73FB2A103J	CHIP R 10K J 1/10W		
R568			RK73FB2A103J	CHIP R 10K J 1/10W		
R570			RK73FB2A103J	CHIP R 10K J 1/10W		
R577			RK73FB2A103J	CHIP R 10K J 1/10W		
R580			RK73FB2A222J	CHIP R 2.2K J 1/10W	E1T1Q1 E2	
R580			RK73FB2A222J	CHIP R 2.2K J 1/10W		
R582			RK73FB2A102J	CHIP R 1.0K J 1/10W		
W303			R92-0679-05	CHIP R 0 OHM		
W304-306			R92-0670-05	CHIP R 0 OHM		
W309,310			R92-0679-05	CHIP R 0 OHM		
W312			R92-0679-05	CHIP R 0 OHM		
W314			R92-0679-05	CHIP R 0 OHM		
W315			R92-0670-05	CHIP R 0 OHM		
W316-318			R92-0679-05	CHIP R 0 OHM		
W501,502			R92-0670-05	CHIP R 0 OHM	KP1Y1 M1X1K1	
W501,502			R92-0670-05	CHIP R 0 OHM		

L : Scandinavia K : USA P : Canada R : Mexico C : China I : Malaysia  
 Y : PX(Far East, Hawaii) T : Europe E : Europe G : Germany V : China (Shanghai)  
 Y : AAFES(Europe) X : Australia Q : Russia H : Korea M : Other Areas  $\Delta$  indicates safety critical components.

## PARTS LIST

24

\* New Parts  
 Parts without **Parts No.** are not supplied.  
 Les articles non mentionnés dans le **Parts No.** ne sont pas fournis.  
 Teile ohne **Parts No.** werden nicht geliefert.

Ref. No	Add-ress	New Parts	Parts No.	Description	Desti-nation	Re-marks
W501,502			R92-0670-05	CHIP R 0 OHM		P2K2P3
K1			S76-0061-05	MAGNETIC RELAY		
K2			S76-0061-05	MAGNETIC RELAY		7
K2			S76-0061-05	MAGNETIC RELAY		6
K3 ,4			S76-0061-05	MAGNETIC RELAY		
S501-505			S70-0031-05	TACT SWITCH		
S507			S70-0031-05	TACT SWITCH		
S509-512			S70-0031-05	TACT SWITCH		
S514-516			S70-0031-05	TACT SWITCH		
S520,521			S70-0031-05	TACT SWITCH		
S517			T99-0602-05	ROTARY ENCODER		
S518,519			T99-0605-05	ROTARY ENCODER		
D3 ,4			MTZJ5.1(B)	ZENER DIODE		
D3 ,4			RD5.1ES(B2)	ZENER DIODE		
D5 ,6			MTZJ6.8(B)	ZENER DIODE		
D5 ,6			RD6.8ES(B2)	ZENER DIODE		
D7			MTZJ5.1(B)	ZENER DIODE		
D7			RD5.1ES(B2)	ZENER DIODE		
D8			MTZJ11(B)	ZENER DIODE		
D8			RD11ES(B2)	ZENER DIODE		
D10			MTZJ8.2(B)	ZENER DIODE		7
D10			MTZJ8.2(B)	ZENER DIODE		6
D10			RD8.2ES(B2)	ZENER DIODE		7
D10			RD8.2ES(B2)	ZENER DIODE		6
D11			MTZJ7.5(B)	ZENER DIODE		7
D11			MTZJ7.5(B)	ZENER DIODE		6
D11			RD7.5ES(B2)	ZENER DIODE		6
D11			RD7.5ES(B2)	ZENER DIODE		7
D12 ,13			MTZJ8.2(B)	ZENER DIODE		7
D12 ,13			MTZJ8.2(B)	ZENER DIODE		6
D12 ,13			RD8.2ES(B2)	ZENER DIODE		7
D12 ,13			RD8.2ES(B2)	ZENER DIODE		6
D14 ,15			MTZJ10(B)	ZENER DIODE		6
D14 ,15			MTZJ10(B)	ZENER DIODE		7
D14 ,15			RD10ES(B2)	ZENER DIODE		7
D14 ,15			RD10ES(B2)	ZENER DIODE		6
D19			MA111	DIODE		
D20			MA111	DIODE		7
D20			MA111	DIODE		6
D21 -23			MA111	DIODE		
D24			MTZJ4.7(B)	ZENER DIODE		
D24			RD4.7ES(B2)	ZENER DIODE		
D25			MTZJ3.3(B)	ZENER DIODE		
D25			RD3.3ES(B2)	ZENER DIODE		
D26			MA111	DIODE		
D31 ,32			D4SBL20UF03	DIODE		
D33 -36			S5688B(TPB5)	DIODE		
D37 ,38			MTZJ16(B)	ZENER DIODE		
D37 ,38			RD16ES(B2)	ZENER DIODE		
D39 ,40			MTZJ18(B)	ZENER DIODE		
D39 ,40			RD18ES(B2)	ZENER DIODE		
D50 ,51			MA111	DIODE		
D50 ,51			MA111	DIODE		6
D52			MA111	DIODE		7
						Y1M1X1

L : Scandinavia K : USA P : Canada R : Mexico C : China I : Malaysia  
 Y : PX(Far East, Hawaii) T : Europe E : Europe G : Germany V : China (Shanghai)  
 Y : AAFES(Europe) X : Australia Q : Russia H : Korea M : Other Areas  $\Delta$  indicates safety critical components.

\* New Parts  
Parts without **Parts No.** are not supplied.  
Les articles non mentionnés dans le **Parts No.** ne sont pas fournis.  
Teile ohne **Parts No.** werden nicht geliefert.

25

Ref. No	Add-ress	New Parts	Parts No.	Description	Desti-nation	Re-marks
D53			MA111	DIODE		6
D53			MA111	DIODE		7
D54			MA111	DIODE		7
D54			MA111	DIODE		6
D55			MA111	DIODE		7
D55			MA111	DIODE		6
D56			MTZJ7.5(B)	ZENER DIODE		
D56			RD7.5ES(B2)	ZENER DIODE		
D504			HSS104A	DIODE	Q1E2	
D504			HSS104A	DIODE	Y1M1X1	
D504			1SS133	DIODE	Q1E2	
D504			1SS133	DIODE	Y1M1X1	
D505			HSS104A	DIODE	E1T1	
D505			1SS133	DIODE	E1T1	
D506			HSS104A	DIODE	K1P2	7
D506			1SS133	DIODE	K1P2	7
D507			HSS104A	DIODE	Q1E2	7
D507			1SS133	DIODE	Q1E2	7
D508,509			HSS104A	DIODE		
D508,509			1SS133	DIODE	KP1K1	
D510			HSS104A	DIODE	E1T1Q1	
D510			HSS104A	DIODE	E2	
D510			HSS104A	DIODE	Y1M1X1	
D510			1SS133	DIODE	E1T1Q1	
D510			1SS133	DIODE	E2	
D510			1SS133	DIODE	Y1M1X1	
D511-521			HSS104A	DIODE		
D511-521			1SS133	DIODE		
D522			HSS104A	DIODE		5
D522			1SS133	DIODE		5
D523			HSS104A	DIODE		
D523			1SS133	DIODE		
D524			HSS104A	DIODE	E1T1Q1	
D524			HSS104A	DIODE	E2	
D524			1SS133	DIODE	E1T1Q1	
D524			1SS133	DIODE	E2	
D526			MTZJ6.2(B)	ZENER DIODE		
D526			RD6.2ES(B2)	ZENER DIODE		
D529			HSS104A	DIODE		
D529			1SS133	DIODE		
ED51			11-MT-116GK	INDICATOR TUBE		
Δ IC1			TA7815SB	ANALOGUE IC		
Δ IC2			TA79015SB	ANALOGUE IC		
Δ IC3		*	STK407-090K	HYBRID IC		5
Δ IC3		*	STK411-230D	HYBRID IC		7
Δ IC3		*	STK411-230D	HYBRID IC		6
Δ IC3		*	STK411-230K	HYBRID IC	KP1Y1	7
Δ IC3		*	STK411-230K	HYBRID IC	M1X1K1	7
Δ IC3		*	STK411-230K	HYBRID IC	P2K2P3	7
Δ IC4		*	STK407-290K	HYBRID IC		5
Δ IC4		*	STK410-030D	HYBRID IC		7
Δ IC4		*	STK410-030D	HYBRID IC		6
Δ IC4		*	STK410-030K	HYBRID IC		7
Δ IC4		*	STK410-030K	HYBRID IC		6
Δ IC5			NJM4580ED	ANALOGUE IC		

L : Scandinavia K : USA P : Canada R : Mexico C : China I : Malaysia  
Y : PX(Far East, Hawaii) T : Europe E : Europe G : Germany V : China (Shanghai)  
Y : AAFES(Europe) X : Australia Q : Russia H : Korea M : Other Areas Δ indicates safety critical components.

\* New Parts  
Parts without **Parts No.** are not supplied.  
Les articles non mentionnés dans le **Parts No.** ne sont pas fournis.  
Teile ohne **Parts No.** werden nicht geliefert.

26

Ref. No	Add-ress	New Parts	Parts No.	Description	Desti-nation	Re-marks
IC6			TC9164AF	MOS-IC		
IC7			TC9162AF	MOS-IC		
IC8			NJM4565MD	IC(OP AMP X2)		
IC9			M62446FP	ANALOGUE IC		
IC12			NJM4565MD	IC(OP AMP X2)		
IC16			M62460AFP	ANALOGUE IC		
IC17			BU4066BCF	IC(ANALOG SWITCH X4)		
IC18			NJM2279M	ANALOGUE IC		
IC19			M5278L05M	ANALOGUE IC		
IC51			CXP82832-144Q	MI-COM IC		KP1Y1
IC51			CXP82832-144Q	MI-COM IC		M1X1K1
IC51			CXP82832-144Q	MI-COM IC		P2K2P3
IC51			CXP82852-130Q	MI-COM IC		E1T1Q1
IC51			CXP82852-130Q	MI-COM IC		E2
IC52			X24C02S	MEMORY IC		E1T1Q1
IC52			X24C02S	MEMORY IC		E2
IC52			X24C02S	MEMORY IC		Y1M1X1
IC53			S-80740AL-A4	IC(VOLTAGE DETECTOR)		
IC54			SAA6579T	ANALOGUE IC		E1T1Q1
IC54			SAA6579T	ANALOGUE IC		E2
IC54			SAA6579T/R	ANALOGUE IC		E1T1Q1
IC54			SAA6579T/R	ANALOGUE IC		E2
Q1 -11			2SC2878(B)	TRANSISTOR		
Q12			2SC4213(B)	TRANSISTOR		
Q13 ,14			2SA1586(Y,GR)	TRANSISTOR		
Q13 ,14			2SA1611(M5,M6)	TRANSISTOR		
Q15 -19			2SC1845(F,E)	TRANSISTOR		
Q20			DTC123JUA	DIGITAL TRANSISTOR		
Q21			DTC123JUA	DIGITAL TRANSISTOR		7
Q22 ,23			DTC123JUA	DIGITAL TRANSISTOR		
Q24 ,25			2SC3722K(R,S)	TRANSISTOR		
Q26			2SA1255	TRANSISTOR		
Q29			2SC2631(S,T)	TRANSISTOR		
Q30			2SA1123(S,T)	TRANSISTOR		
Q31			2SA1534A	TRANSISTOR		5
Δ Q31			2SB1640	TRANSISTOR		7
Δ Q31			2SB1640	TRANSISTOR		6
Q32 -34			2SC3722K(R,S)	TRANSISTOR		
Q35			2SA1255	TRANSISTOR		
Q36 ,37			2SC3722K(R,S)	TRANSISTOR		
Q40			2SC4213(B)	TRANSISTOR		7
Q40			2SC4213(B)	TRANSISTOR		6
Q41			DTC113ZUA	DIGITAL TRANSISTOR		7
Q41			DTC113ZUA	DIGITAL TRANSISTOR		6
Q41			UN5219	DIGITAL TRANSISTOR		7
Q41			UN5219	DIGITAL TRANSISTOR		6
Q42			2SC4213(B)	TRANSISTOR		7
Q42			2SC4213(B)	TRANSISTOR		6
Q501			2SC4116(Y,GR)	TRANSISTOR		Y1M1X1
Q501			2SC4177(L5,L6)	TRANSISTOR		Y1M1X1
Q501			2SC4116(Y,GR)	TRANSISTOR		
Q503			2SC4177(L5,L6)	TRANSISTOR		
A501			W02-2625-05	OPTIC RECEIVING MODULE		

L : Scandinavia K : USA P : Canada R : Mexico C : China I : Malaysia  
Y : PX(Far East, Hawaii) T : Europe E : Europe G : Germany V : China (Shanghai)  
Y : AAFES(Europe) X : Australia Q : Russia H : Korea M : Other Areas Δ indicates safety critical components.

KRF-V5010W6010N/7010MR-205/206/207/255/257  
PARTS LIST

# KRF-V5010/V6010/V7010/VR-205/206/207/255/257

## PARTS LIST

HOW TO READ THE PARTS LIST

ABBREVIATION OF MODEL AND MASS PRODUCTION'S DESTINATIONS

MODEL	ABB.	Australia	Canada	China	England	Europe	Germany	Korea	Malaysia
KRF-5010	5	X1	-	-	T1	E1	-	-	-
KRF-5010E		-	-	-	-	E2	-	-	-
KRF-5010W		-	-	-	-	-	-	-	-
VR-205		-	P1	-	-	-	-	-	-
VR-255		-	P2	-	-	-	-	-	-
KRF-V6010	6	X1	-	-	-	E1	-	-	-
KRF-V6010E		-	-	-	-	E2	-	-	-
KRF-V6010W		-	-	-	-	-	-	-	-
KRF-V7010	7	X1	-	-	T1	E1	-	-	-
KRF-V7010E		-	-	-	-	E2	-	-	-
KRF-V7010W		-	-	-	-	-	-	-	-
VR-206		-	P3	-	-	-	-	-	-
VR-207		-	P1	-	-	-	-	-	-
VR-257		-	P2	-	-	-	-	-	-
MODEL	ABB.	Mexico	PX/AAFES	Russia	Scandinavia	Shanghai	USA	Other area	
KRF-5010	5	-	Y1	-	-	-	-	M1	-
KRF-5010E		-	-	-	-	-	-	-	-
KRF-5010W		-	-	Q1	-	-	-	-	-
VR-205		-	-	-	-	-	K	-	-
VR-255		-	-	-	-	-	K1	-	-
KRF-V6010	6	-	-	-	-	-	-	M1	-
KRF-V6010E		-	-	-	-	-	-	-	-
KRF-V6010W		-	-	Q1	-	-	-	-	-
KRF-V7010	7	-	Y1	-	-	-	-	M1	-
KRF-V7010E		-	-	-	-	-	-	-	-
KRF-V7010W		-	-	Q1	-	-	-	-	-
VR-206		-	-	-	-	-	K2	-	-
VR-207		-	-	-	-	-	K	-	-
VR-257		-	-	-	-	-	K1	-	-

# KRF-V5010/V6010/V7010/VR-205/206/207/255/257

## SPECIFICATIONS

### For U.S.A and Canada

#### AUDIO section

Rated power output during STEREO operation  
VR-207, VR-257, VR-206

100 watts per channel minimum RMS, both channels driven, at 8 Ω from 40 Hz to 20 kHz with no more than 0.7% total harmonic distortion.(FTC)

VR-205, VR-255

50 watts per channel minimum RMS, both channels driven, at 8 Ω from 40 Hz to 20 kHz with no more than 0.7% total harmonic distortion.(FTC)

Effective power output during SURROUND operation

VR-207, VR-257, VR-206  
FRONT (1kHz, 0.7% T.H.D. at 8 Ω one channel driven)  
..... 100 W + 100 W  
CENTER (1kHz, 0.7% T.H.D. at 8 Ω one channel driven)  
..... 100 W  
SURROUND (1kHz, 0.7% T.H.D. at 8 Ω one channel driven)  
..... 100 W + 100 W

VR-205, VR-255  
FRONT (1kHz, 0.7% T.H.D. at 8 Ω one channel driven)  
..... 50 W + 50 W  
CENTER (1kHz, 0.7% T.H.D. at 8 Ω one channel driven)  
..... 50 W  
SURROUND (1kHz, 0.7% T.H.D. at 8 Ω one channel driven)  
..... 50 W + 50 W

Total harmonic distortion  
VR-207, VR-257, VR-206 ..... 0.03% (1 kHz, 50W, 8 Ω)  
VR-205, VR-255 ..... 0.03% (1 kHz, 25W, 8 Ω)

Signal to noise ratio (IHF'66)  
PHONO (MM) ..... 75 dB  
CD ..... 91 dB

Input sensitivity / impedance  
PHONO (MM) ..... 2.5 mV / 27 kΩ  
CD ..... 200 mV / 47 kΩ  
DVD 6CH (SUBWOOFER) ..... 200 mV / 10 kΩ

Output level / impedance  
TAPE REC ..... 200 mV / 1 kΩ  
PRE OUT (CENTER, SURROUND) ..... 1 V / 1 kΩ  
(only VR-207, VR-257, VR-206)  
PRE OUT (SUBWOOFER) ..... 1 V / 600 Ω

Tone control  
BASS ..... ±10 dB (at 100 Hz)  
TREBLE ..... ±10 dB (at 10 kHz)

#### VIDEO section

VIDEO inputs / outputs  
VIDEO (composite) ..... 1 V<sub>p-p</sub> / 75 Ω

#### TV tuner section (For VR-257)

Reception frequency ..... 65.75 MHz (3ch)  
71.75 MHz (4ch)

#### FM tuner section

Tuning frequency range ..... 87.5 MHz ~ 108 MHz  
Usable sensitivity (MONO)  
..... 1.6 μV (75 Ω) / 15.2 dBf (75 kHz DEV., SINAD 30 dB)  
50dB quieting sensitivity  
STEREO ..... 31.6 μV (75 Ω) / 41.2 dBf  
Total harmonic distortion (1 kHz)  
MONO ..... 0.6% (65 dBf input)  
STEREO ..... 0.7% (65 dBf input)  
Signal to noise ratio (1 kHz, 75 kHz DEV.)  
MONO ..... 75 dB (65 dBf input)  
STEREO ..... 68 dB (65 dBf input)  
Stereo separation (1 kHz) ..... 38 dB  
Selectivity (±400 kHz) ..... 70 dB  
Frequency response ..... 30 Hz ~ 15kHz, +0.5 dB, -3.0 dB

#### AM tuner section

Tuning frequency range  
10 kHz step ..... 530 kHz ~ 1,700 kHz  
Usable sensitivity (30% mod., S/N 20 dB)  
..... 16 μV / (600 μV/m)  
Signal to noise ratio (30% mod. 1 mV input) ..... 50 dB

#### GENERAL

Power consumption ..... 2.2 A  
AC outlet  
SWITCHED ..... 2 (total 150 W, 1.25 A max.)

Dimensions ..... W : 440 mm (17-5/16")  
H : 144 mm (5-11/16")  
D : 390 mm (15-3/8")

Weight (Net)  
VR-207, VR-257, VR-206 ..... 8.6 kg (19.0 lb)  
VR-205, VR-255 ..... 8.2 kg (18.1 lb)

#### Notes

1. KENWOOD follows a policy of continuous advancements in development. For this reason specifications may be changed without notice.
2. The full performance may not be exhibited in an extremely cold location (under a water-freezing temperature).

# KRF-V5010/V6010/V7010/VR-205/206/207/255/257

## SPECIFICATIONS

### For Europ

#### AUDIO section

Rated power output during STEREO operation

KRF-V7010  
(DIN) 1 kHz, 0.7% at 4 Ω ..... 100 W + 100 W

KRF-V6010  
(DIN) 1 kHz, 0.7% at 4 Ω ..... 90 W + 90 W

KRF-V5010  
(DIN) 1 kHz, 0.7% at 4 Ω ..... 50 W + 50 W

Effective power output during SURROUND operation

KRF-V7010  
FRONT(1kHz, 0.7% T.H.D. at 4 Ω one channel driven)  
..... 100 W + 100 W  
CENTER (1kHz, 0.7% T.H.D. at 4 Ω one channel driven)  
..... 100 W  
SURROUND(1kHz, 0.7% T.H.D. at 4 Ω one channel driven)  
..... 100 W + 100 W

KRF-V6010  
FRONT(1kHz, 0.7% T.H.D. at 4 Ω one channel driven)  
..... 80 W + 80 W  
CENTER (1kHz, 0.7% T.H.D. at 4 Ω one channel driven)  
..... 80 W  
SURROUND(1kHz, 0.7% T.H.D. at 4 Ω one channel driven)  
..... 80 W + 80 W

KRF-V5010  
FRONT(1kHz, 0.7% T.H.D. at 4 Ω one channel driven)  
..... 50 W + 50 W  
CENTER (1kHz, 0.7% T.H.D. at 4 Ω one channel driven)  
..... 50 W  
SURROUND(1kHz, 0.7% T.H.D. at 4 Ω one channel driven)  
..... 50 W + 50 W

Total harmonic distortion

KRF-V7010 ..... 0.03%(1 kHz, 50W, 4 Ω)  
KRF-V6010 ..... 0.03%(1 kHz, 40W, 4 Ω)  
KRF-V5010 ..... 0.03%(1 kHz, 25W, 4 Ω)

Signal to noise ratio

PHONO (MM) ..... 75 dB (IHF'66)  
..... 55 dB (DIN 50mW output)  
CD ..... 91 dB (IHF'66)  
..... 56 dB (DIN 50mW output)

Input sensitivity / impedance

PHONO (MM) ..... 2.5 mV / 27 kΩ  
CD ..... 200 mV / 47 kΩ  
DVD 6CH (SUBWOOFER) ..... 200 mV / 10 kΩ

Output level / impedance

TAPE REC ..... 200 mV / 1 kΩ  
PRE OUT (CENTER, SURROUND) ..... 1 V / 1 kΩ  
(only KRF-V7010, KRF-V6010)  
PRE OUT (SUBWOOFER) ..... 1 V / 600 Ω

Tone control

BASS ..... ±10 dB (at 100 Hz)  
TREBLE ..... ±10 dB (at 10 kHz)

#### VIDEO section

VIDEO inputs / outputs

VIDEO (composite) ..... 1 Vp-p / 75 Ω

#### FM tuner section

Tuning frequency range

U.K. and Europe ..... 87.5 MHz ~ 108 MHz  
Russia ..... 87.5 MHz ~ 108 MHz,  
65.0 MHz ~ 74.0 MHz

Usable sensitivity (DIN, 75 Ω)

MONO ..... 1.2 μV / 13.2 dBf (40 kHz DEV., S/N 26 dB)  
STEREO ..... 35 μV / 42.1 dBf (46 kHz DEV., S/N 46 dB)

Total harmonic distortion (DIN, 1 kHz)

MONO ..... 0.2% (65.2 dBf input)  
STEREO ..... 0.8% (65.2 dBf input)

Signal to noise ratio (DIN weighted, 1 kHz)

U.K. and Europe  
MONO ..... 65 dB (40 kHz DEV., 65.2 dBf input)  
STEREO ..... 60 dB (46 kHz DEV., 65.2 dBf input)  
Russia  
MONO ..... 63 dB (40 kHz DEV., 65.2 dBf input)  
STEREO ..... 58 dB (46 kHz DEV., 65.2 dBf input)

Stereo separation (DIN, 1 kHz) ..... 36 dB

Selectivity (DIN, ±300 kHz) ..... 64 dB

Frequency response (30 Hz ~ 15kHz) ..... +0.5 dB, -3.0 dB

#### AM tuner section

Tuning frequency range ..... 531 kHz ~ 1,602 kHz

Usable sensitivity (30% mod., S/N 20 dB)

..... 16 μV / (600 μV/m)

Signal to noise ratio (30% mod., 1 mV input) ..... 50 dB

#### GENERAL

Power consumption

KRF-V7010, KRF-V6010 ..... 280 W  
KRF-V5010 ..... 210 W

AC outlet

SWITCHED ..... 2 (total 150 W max.)

Dimensions ..... W : 440 mm

H : 144 mm

KRF-V7010 ..... D : 400 mm

KRF-V6010, KRF-V5010 ..... D : 390 mm

Weight (Net)

KRF-V7010, KRF-V6010 ..... 8.6 kg

KRF-V5010 ..... 8.2 kg

#### Notes

1. KENWOOD follows a policy of continuous advancements in development. For this reason specifications may be changed without notice.
2. The full performance may not be exhibited in an extremely cold location (under a water-freezing temperature).

# KRF-V5010/V6010/V7010/VR-205/206/207/255/257

## SPECIFICATIONS

### For other countries

#### AUDIO section

Effective power output during STEREO operation

KRF-V7010	
1kHz, 10% T.H.D., at 8 Ω	140 W + 140 W
KRF-V6010	
1kHz, 10% T.H.D., at 8 Ω	120 W + 120 W
KRF-V5010	
1kHz, 10% T.H.D., at 8 Ω	70 W + 70 W

Rated power output during STEREO operation

KRF-V7010	
DIN (63 Hz ~ 12.5 kHz, 0.7%, 8 Ω)	110 W + 110 W

100 watts per channel minimum RMS, both channels driven, at 8 Ω from 40 Hz to 20 kHz with no more than 0.7% total harmonic distortion.(FTC)

KRF-V6010	
DIN (63 Hz ~ 12.5 kHz, 0.7%, 8 Ω)	80 W + 80 W

80 watts per channel minimum RMS, both channels driven, at 8 Ω from 40 Hz to 20 kHz with no more than 0.7% total harmonic distortion.(FTC)

KRF-V5010	
DIN (63 Hz ~ 12.5 kHz, 0.7%, 8 Ω)	50 W + 50 W

50 watts per channel minimum RMS, both channels driven, at 8 Ω from 40 Hz to 20 kHz with no more than 0.7% total harmonic distortion.(FTC)

Effective power output during SURROUND operation

KRF-V7010	
FRONT (1kHz, 10% T.H.D. at 8 Ω one channel driven)	100 W + 100 W
CENTER (1kHz, 10% T.H.D. at 8 Ω one channel driven)	100 W
SURROUND (1kHz, 10% T.H.D. at 8 Ω one channel driven)	100 W + 100 W

KRF-V6010	
FRONT (1kHz, 10% T.H.D. at 8 Ω one channel driven)	80 W + 80 W
CENTER (1kHz, 10% T.H.D. at 8 Ω one channel driven)	80 W
SURROUND (1kHz, 10% T.H.D. at 8 Ω one channel driven)	80 W + 80 W

KRF-V5010	
FRONT (1kHz, 10% T.H.D. at 8 Ω one channel driven)	50 W + 50 W
CENTER (1kHz, 10% T.H.D. at 8 Ω one channel driven)	50 W
SURROUND (1kHz, 10% T.H.D. at 8 Ω one channel driven)	50 W + 50 W

Total harmonic distortion

KRF-V7010	0.03%(1 kHz, 50W, 8 Ω)
KRF-V6010	0.03%(1 kHz, 40W, 8 Ω)
KRF-V5010	0.03%(1 kHz, 25W, 8 Ω)

Signal to noise ratio (IHF'66)

PHONO (MM)	75 dB
CD	91 dB

Input sensitivity / impedance

PHONO (MM)	2.5 mV / 27 kΩ
CD	200 mV / 47 kΩ
DVD 6CH (SUBWOOFER)	200 mV / 10 kΩ

Output level / impedance

TAPE REC	200 mV / 1 kΩ
PRE OUT (CENTER, SURROUND)	1 V / 1 kΩ
(only KRF-V7010, KRF-V6010)	
PRE OUT (SUBWOOFER)	1 V / 600 Ω

Tone control

BASS	±10 dB (at 100 Hz)
TREBLE	±10 dB (at 10 kHz)

#### VIDEO section

VIDEO inputs / outputs

VIDEO (composite)	1 Vp-p / 75 Ω
-------------------	---------------

#### FM tuner section

Tuning frequency range	87.5 MHz ~ 108 MHz
Usable sensitivity (MONO)	1.6 μV (75 Ω) / 15.2 dBf (75 kHz DEV., SINAD 30 dB)
50dB quieting sensitivity	
STEREO	31.6 μV (75 Ω) / 41.2 dBf
Total harmonic distortion (1 kHz)	
MONO	0.6% (65 dBf input)
STEREO	0.7% (65 dBf input)
Signal to noise ratio (1 kHz, 75 kHz DEV.)	
MONO	75 dB (65 dBf input)
STEREO	68 dB (65 dBf input)
Stereo separation (1 kHz)	38 dB
Selectivity (±400 kHz)	50 dB
Frequency response	30 Hz ~ 15kHz, +0.5 dB, -3.0 dB

#### AM tuner section

Tuning frequency range	
9 kHz step	531 kHz ~ 1,602 kHz
10 kHz step	530 kHz ~ 1,610 kHz
Usable sensitivity (30% mod., S/N 20 dB)	16 μV / (600 μV/m)
Signal to noise ratio (30% mod. 1 mV input)	50 dB

#### GENERAL

Power consumption

KRF-V7010, KRF-V6010	280 W
KRF-V5010	210 W

AC outlet

SWITCHED (for Australia)	1 (total 150 W max.)
SWITCHED (except Australia)	2 (total 150 W max.)

Dimensions	W : 440 mm
	H : 144 mm
	D : 390 mm

Weight (Net)

KRF-V7010, KRF-V6010	9.4 kg
KRF-V5010	8.2 kg

Notes

1. KENWOOD follows a policy of continuous advancements in development. For this reason specifications may be changed without notice
2. The full performance may not be exhibited in an extremely cold location (under a water-freezing temperature).

**Note:**

Component and circuit are subject to modification to insure best operation under differing local conditions. This manual is based on General market(M) standard, and provides information on regional circuit modification through use of alternate schematic diagrams, and information on regional component variations through use of parts list.

**KENWOOD CORPORATION**

14-6,Dogenzaka 1-chome, Shibuya-ku, Tokyo, 150-8501 Japan

**KENWOOD SERVICE CORPORATION**

P.O BOX 22745, 2201 East Dominguez St., Long Beach, CA 90801-5745, U.S.A.

**KENWOOD ELECTRONICS CANADA INC.**

6070 Kestrel Road, Mississauga, Ontario, Canada L5T 1S8

**KENWOOD ELECTRONICS LATIN AMERICA S.A.**

P.O BOX 55-2791, Piso 6 plaza Chase, Cl. 47 y Aquilino de la Guardia Panama, Republic de Panama

**KENWOOD ELECTRONICS BRASIL LTDA.**

Av Indianópolis, 628, 04062-001 Planalto Paullista São Paulo-SP-Brasil

**KENWOOD ELECTRONICS U.K. LIMITED**

KENWOOD House, Dwight Road, Watford, Herts., WD1 8EB., United Kingdom

**KENWOOD ELECTRONICS BELGUM N.V.**

Meachelsesteenweg 418, B-1930 Zaventem, Belgium

**KENWOOD ELECTRONICS DEUTSCHLAND GMBH**

Rembrücker Str. 15, 63150 Heusenstamm, Germany

**KENWOOD ELECTRONICS FRANCE S.A.**

13 Boulevard Ney, 75018 Paris, France

**KENWOOD ELECTRONICS ITALIA S.p.A.**

Via G. Sirtori, 7/9 20129, Milano, Italy

**KENWOOD IBÉRICA S.A.**

Bolivia, 239-08020 Barcelona, Spain

**KENWOOD ELECTRONICS AUSTRALIA PTY. LTD.**

(A.C.N. 001499 074)

P.O Box 504, 8 Figtree Drive, Australia Centre, Homebush, N.S.W. 2140, Australia

**KENWOOD & LEE ELECTRONICS, LTD.**

Unit 3712-3724, Level 37, Tower 1, Metroplaza, 223 Hing Fong Road, Kwai Fong N.T., Hong Kong

**KENWOOD ELECTRONICS GULF FZE**

P.O.Box 61318, Jebel Ali, Dubai, U.A.E.

**KENWOOD ELECTRONICS SINGAPORE PTE LTD.**

No. 1 Genting Lane #02-02, KENWOOD Building, Singapore, 349544

**KENWOOD ELECTRONICS (MALAYSIA) SDN BHD.**

#4.01 Level 4, Wisma Academy Lot 4A, Jalan 19/1 46300 Petaling Jaya Selangor Darul Ehsan Malaysia

**KENWOOD ELECTRONICS (THAILAND) CO., LTD.**

573/111 Soi Ramkhamhaeng 39, Ramkhamhaeng Road, Wangthonglang, Bangkok, Bangkok 10301 Thailand